

# Sauna "Hobbit Tiny" 4 x 1,95

**NB! Please read whole manual before start.**

**All given measurements are in millimeters!**

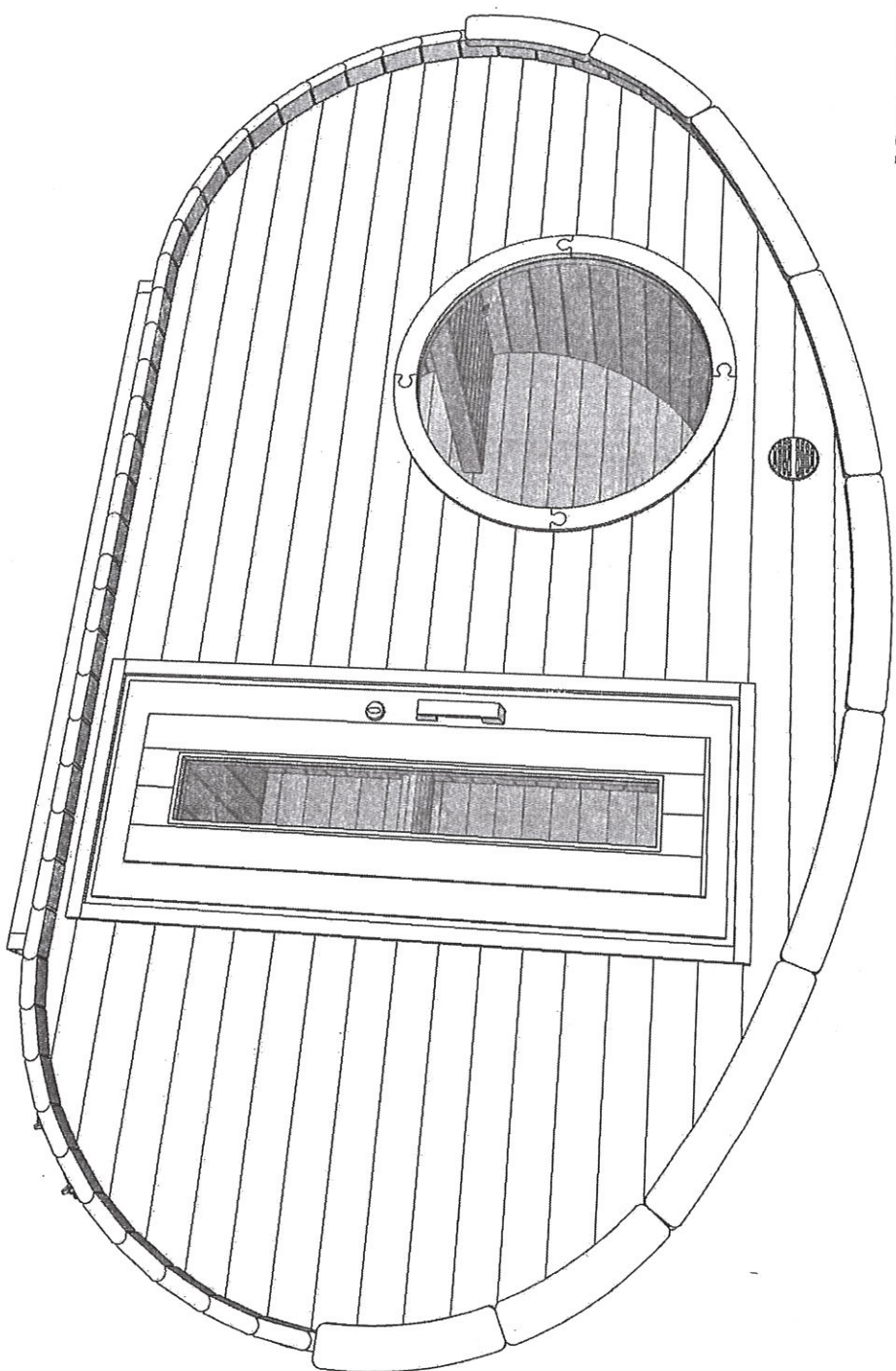

# Sauna "Hobbit" 4 x 1,95

## Details list 1

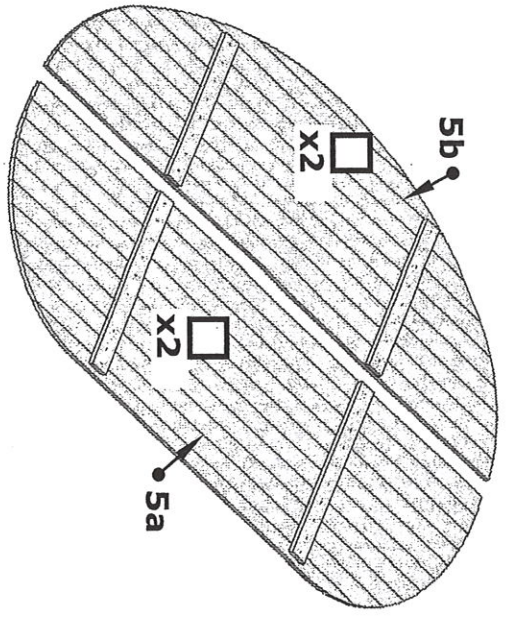
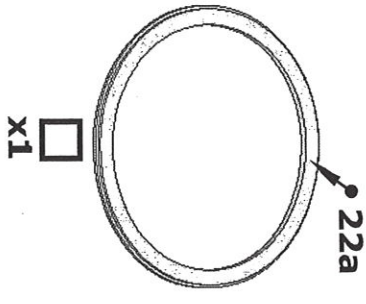
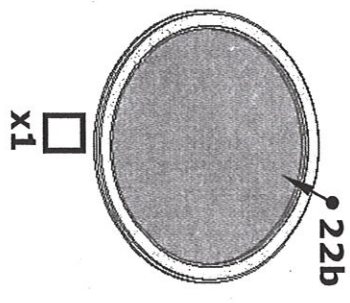
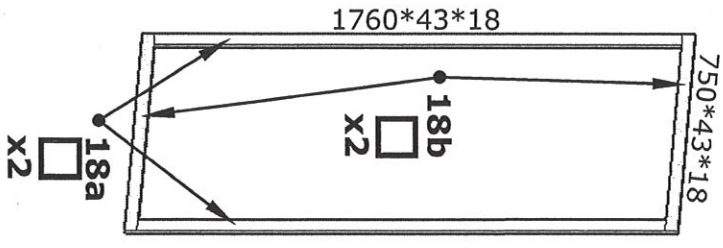
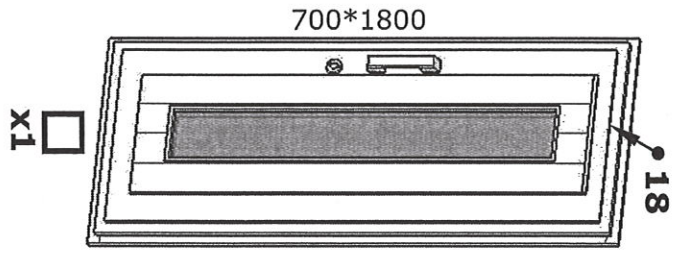
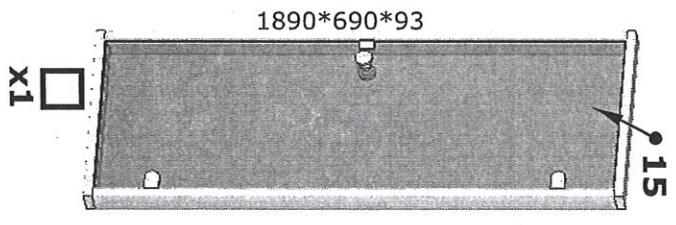
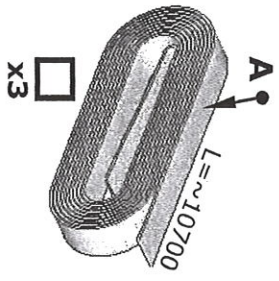
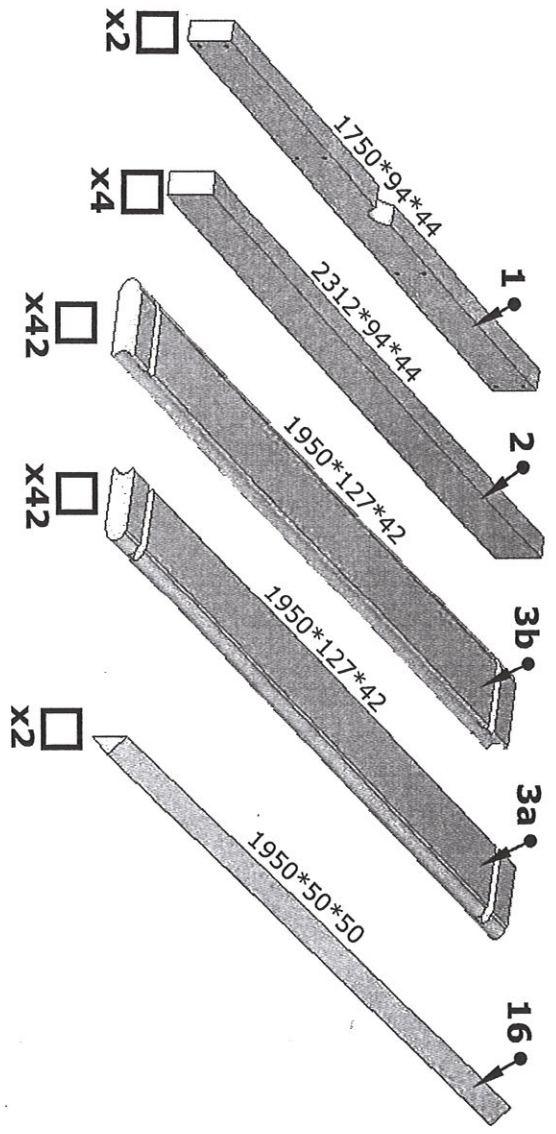

# Sauna "Hobbit" 4 x 1,95

## Details list 2

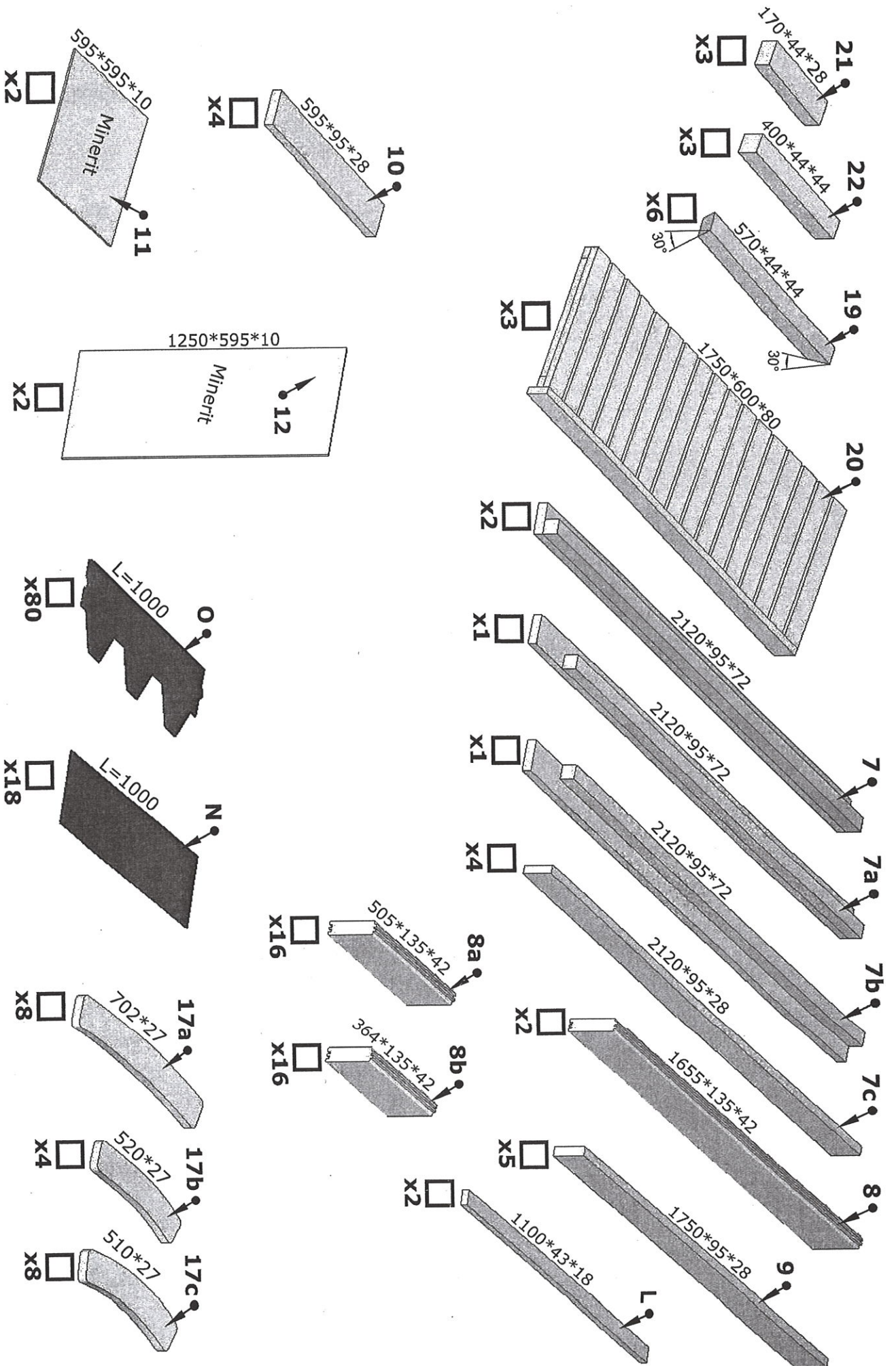

# Sauna "Hobbit" 4 x 1,95

## Details list(in the box)

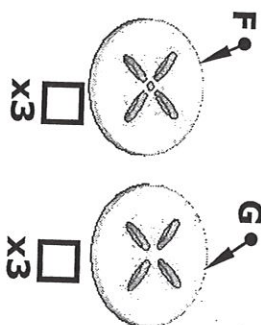
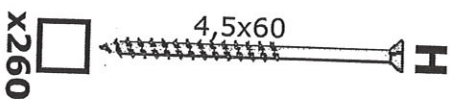
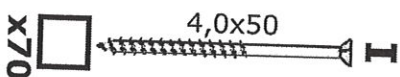
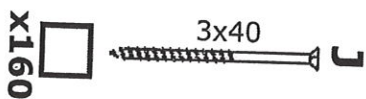
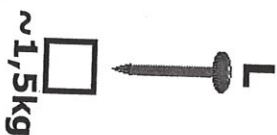
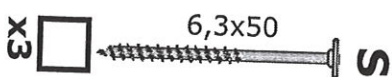
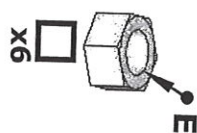
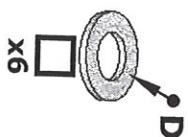
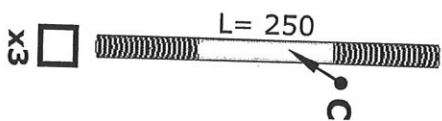
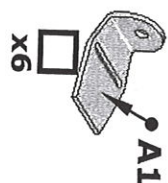
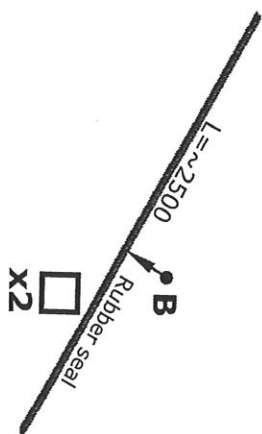

# Sauna "Hobbit" 4 x 1,95

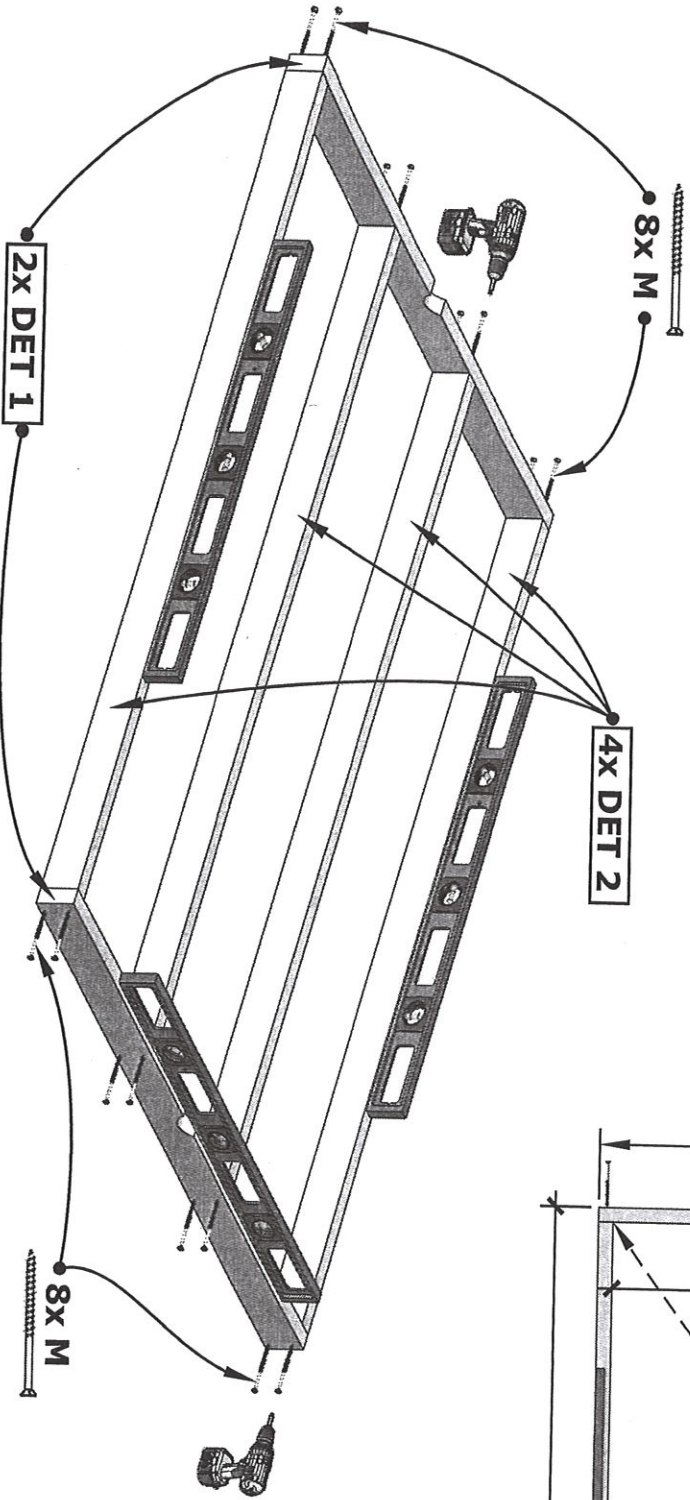
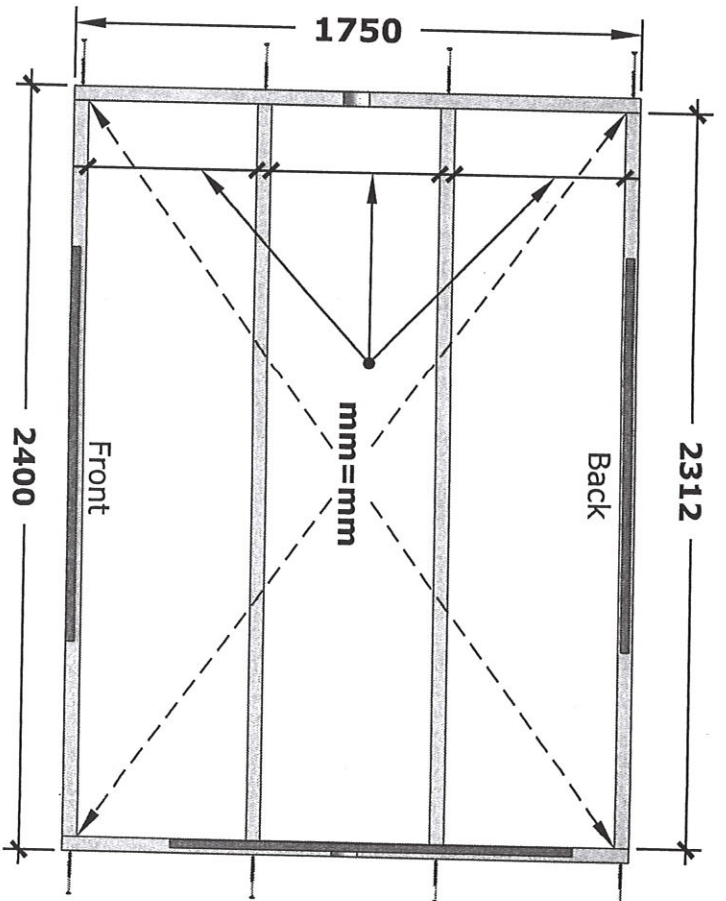
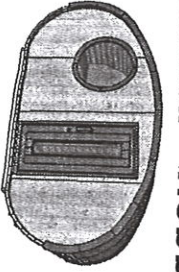

1.

# Sauna "Hobbit" 4 x 1,95

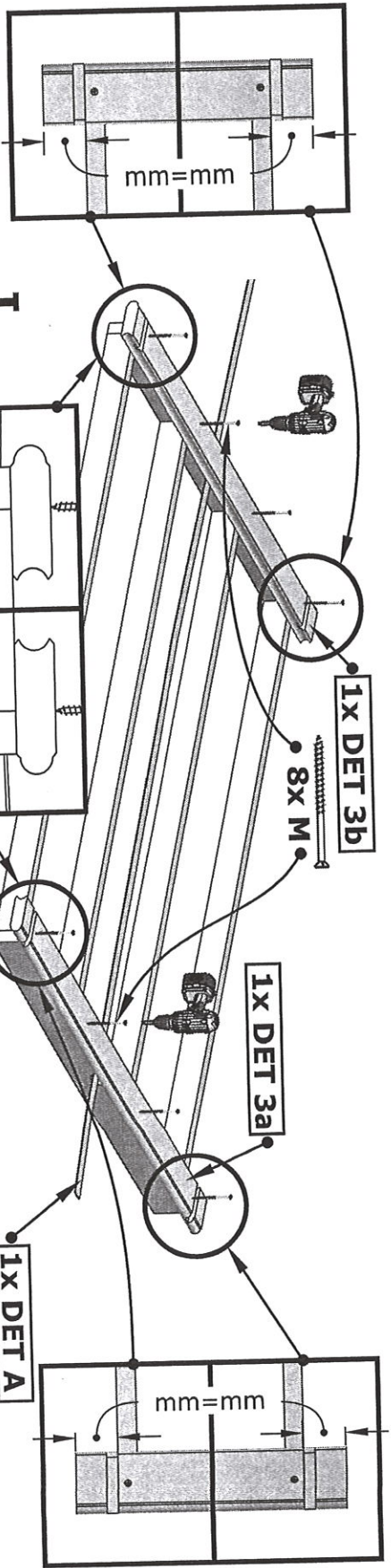
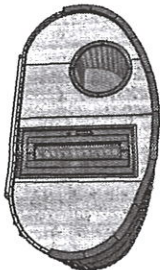

Fix screws over one board, diagonally in every board!

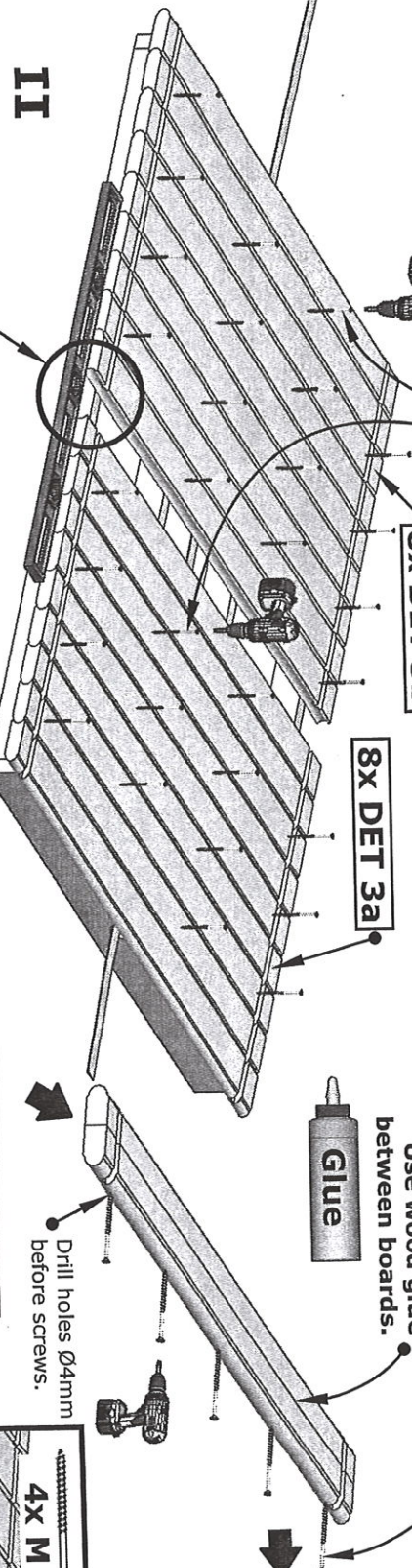

## II

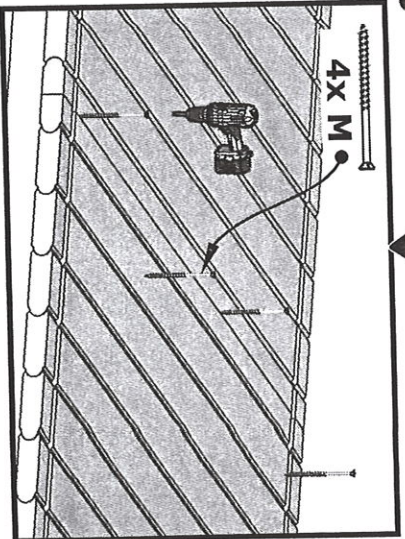
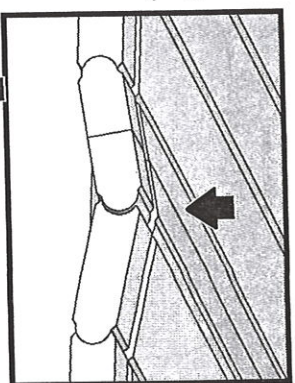
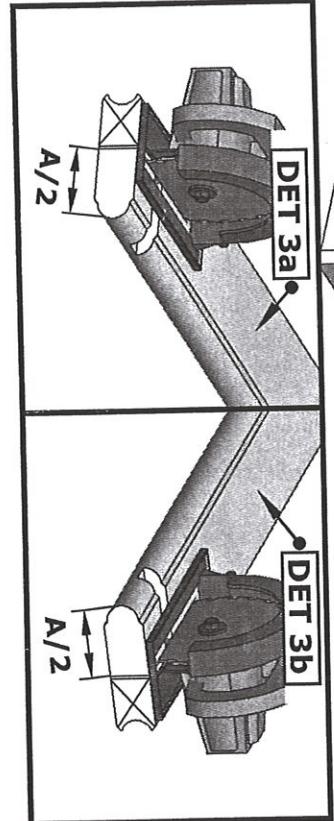
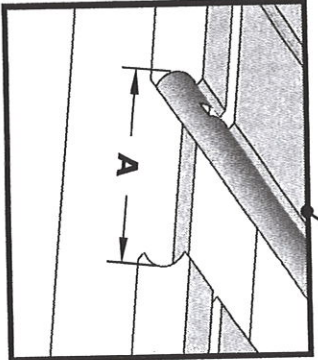

# Sauna "Hobbit" 4 x 1,95

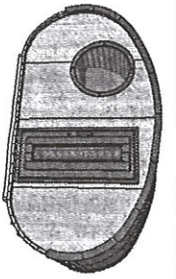

Drill Holes  $\varnothing 10$  in every board, outside.

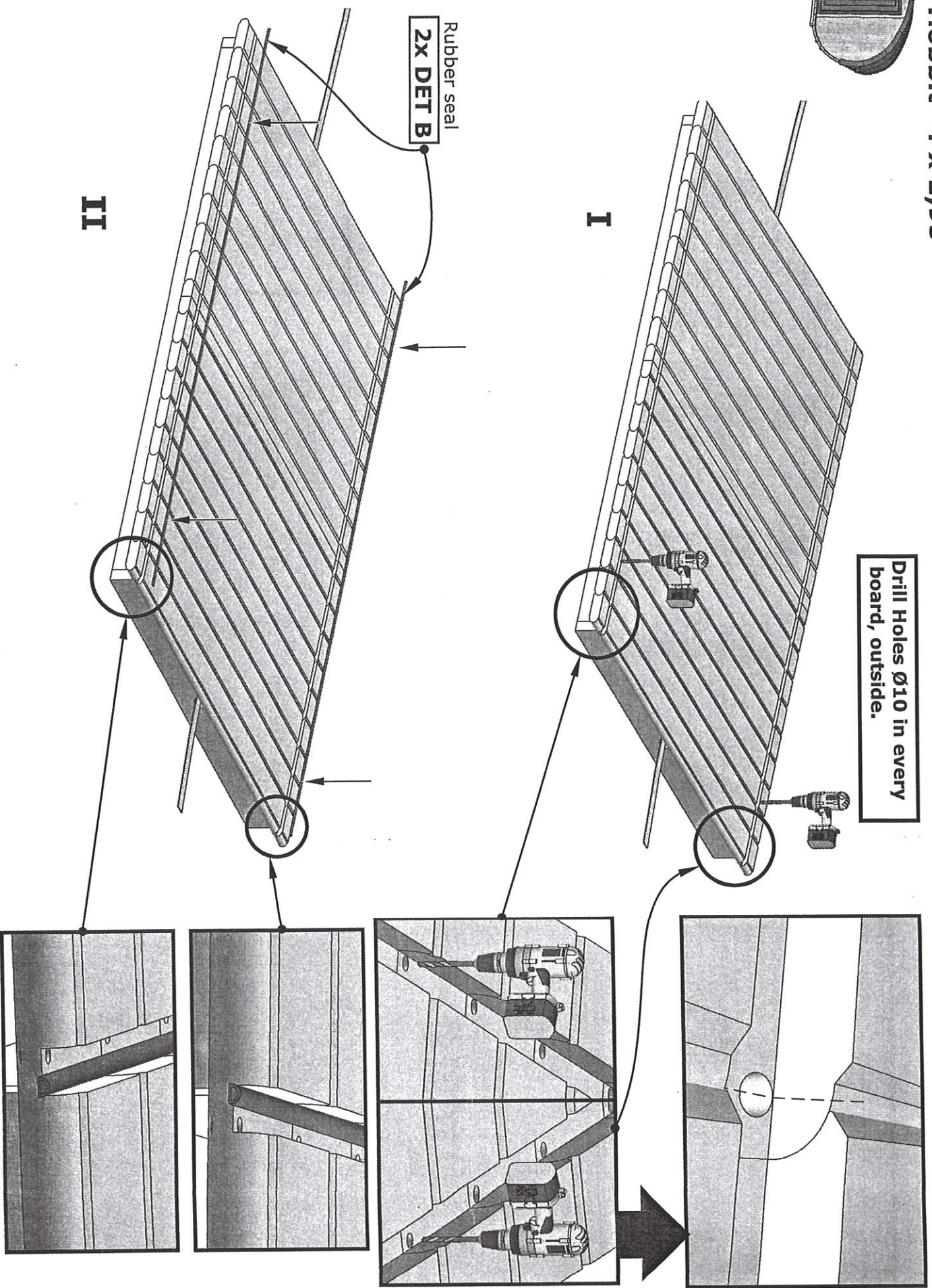

# Sauna "Hobbit Tiny" 4 x 1,95

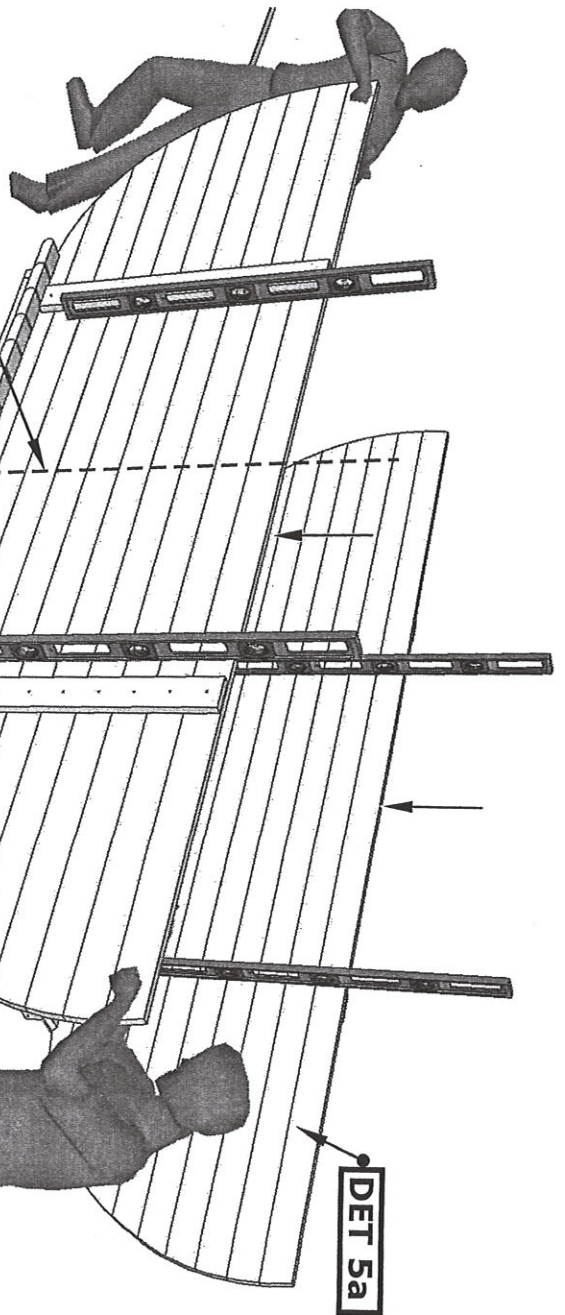
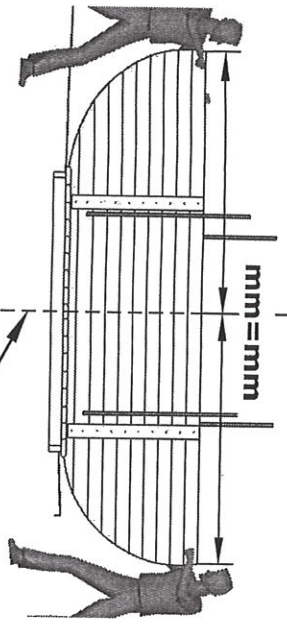
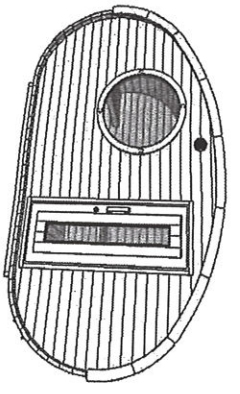

Wall and floor midpoint.

II

2X DET B

DET 5a

DET 5a

I

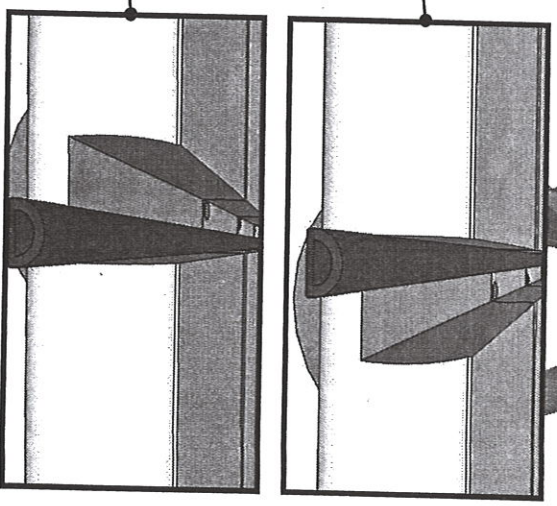
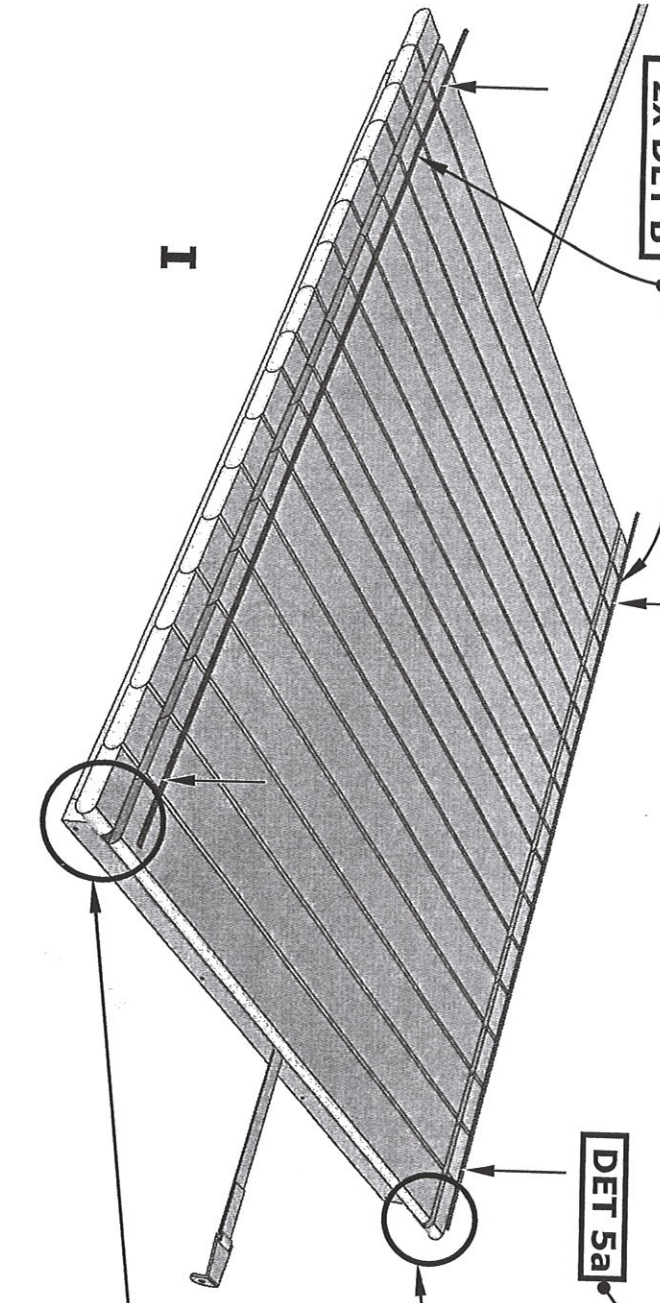



# Sauna "Hobbit Tiny" 4 x 1,95

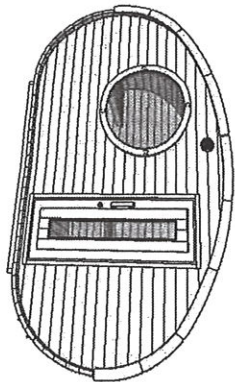

**NB!** Cut some boards from pallet, to support and fix walls if necessary!

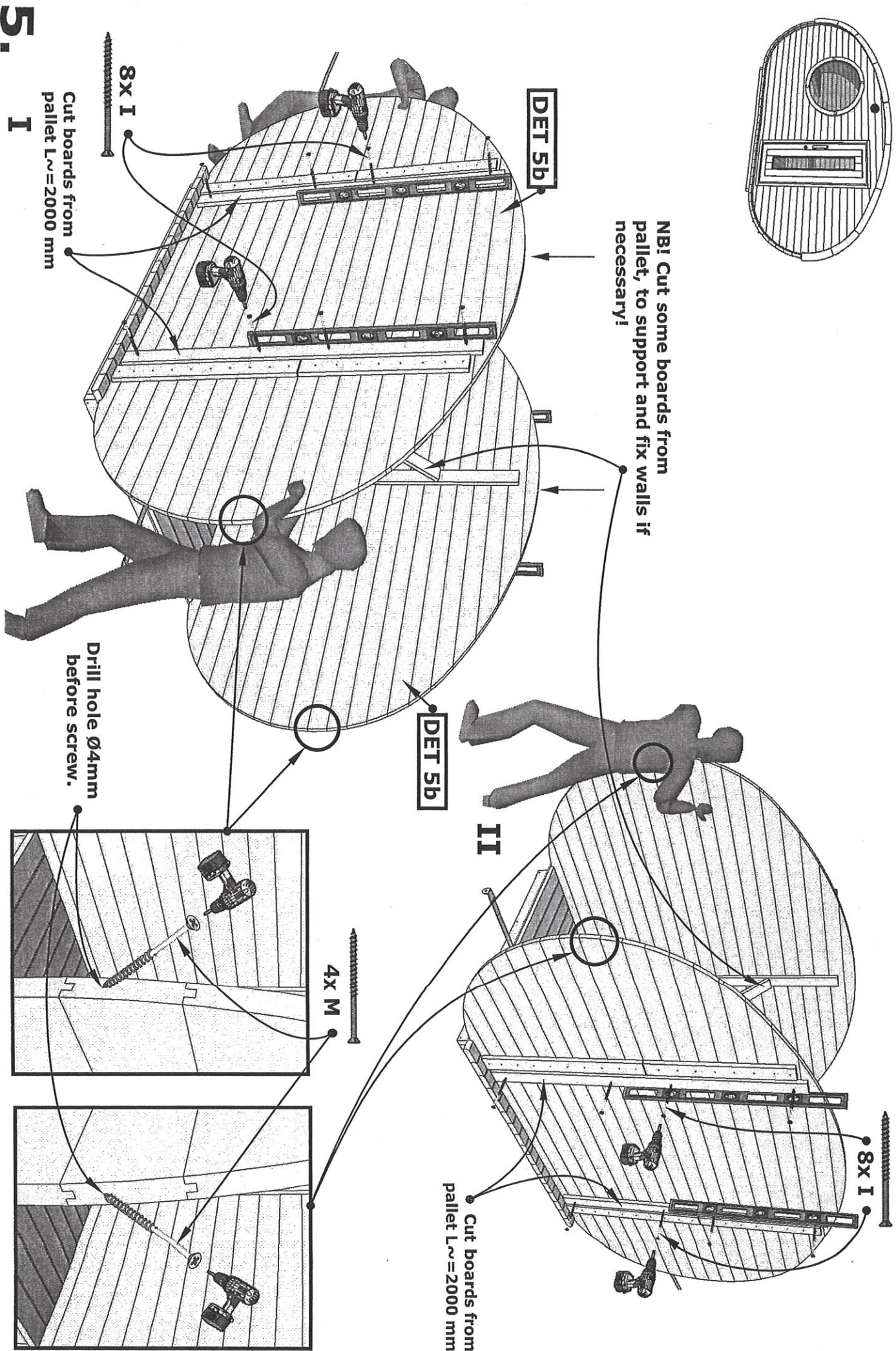

# Sauna "Hobbit" 4 x 1,95

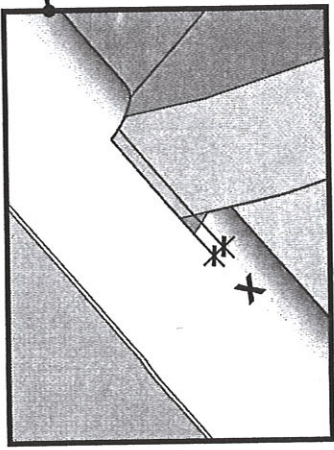
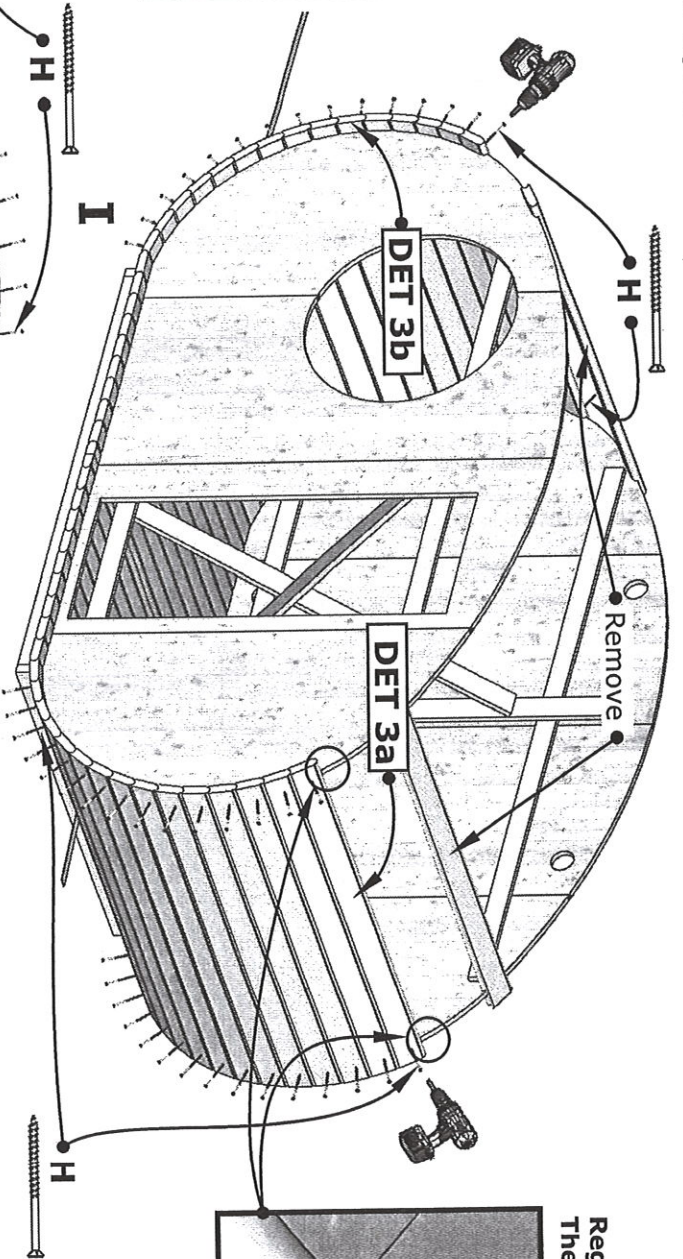
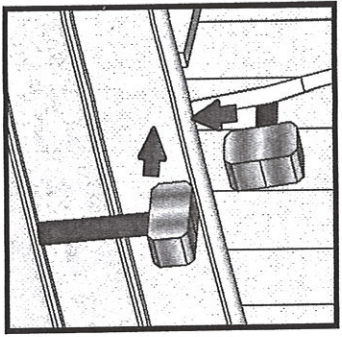
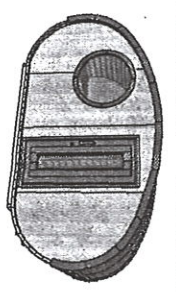

Regular wood X = 7-8 mm.  
Thermo wood X = 3-4 mm.

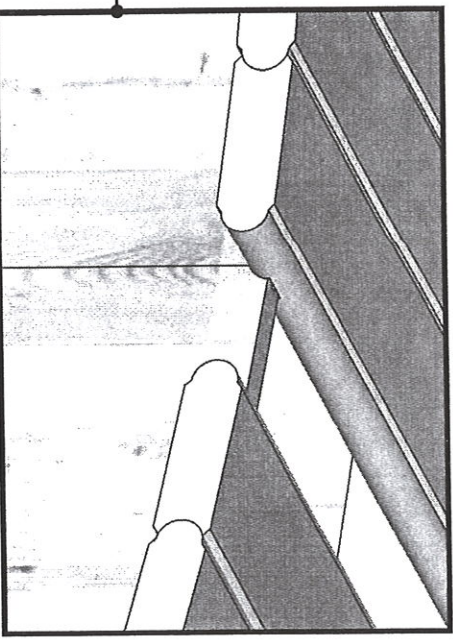
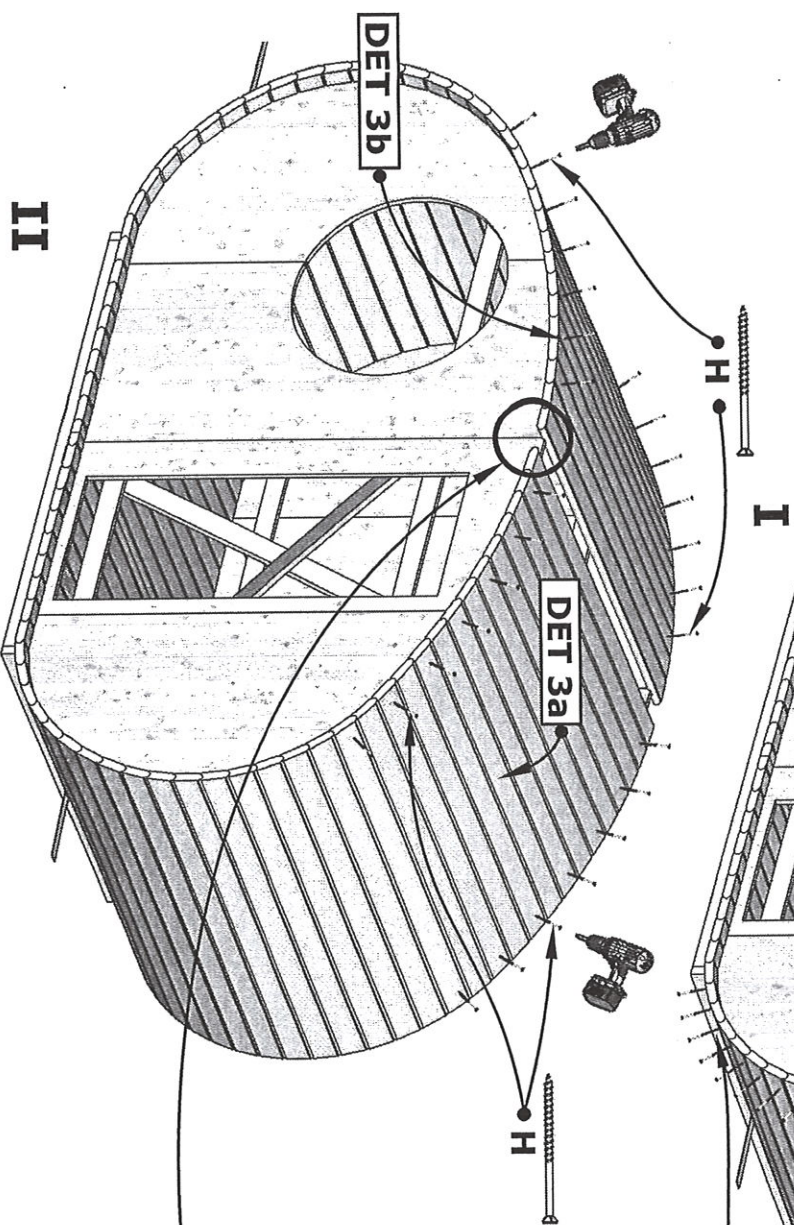

See next page.

# Sauna "Hobbit" 4 x 1,95

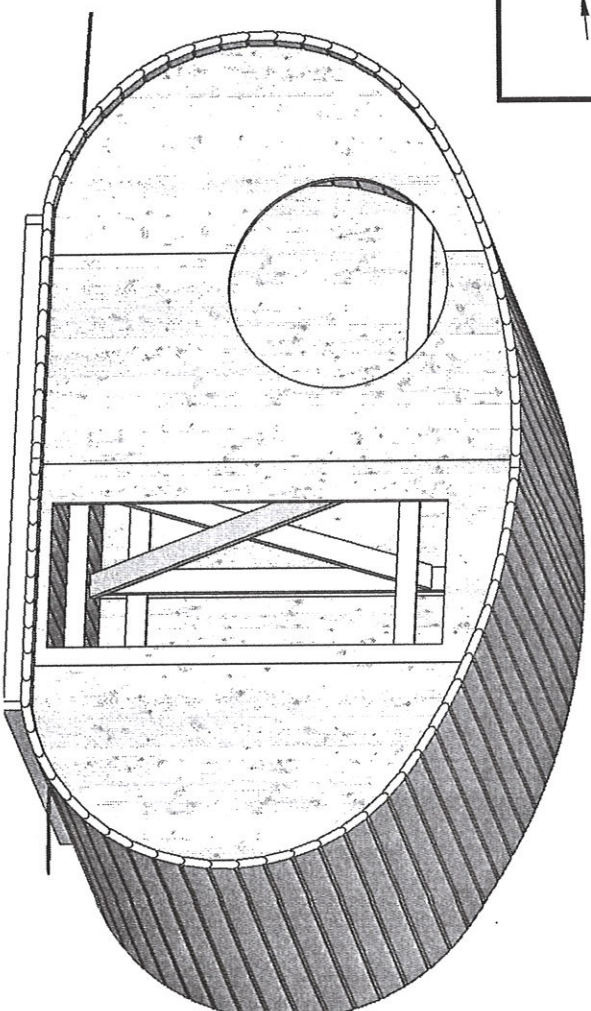
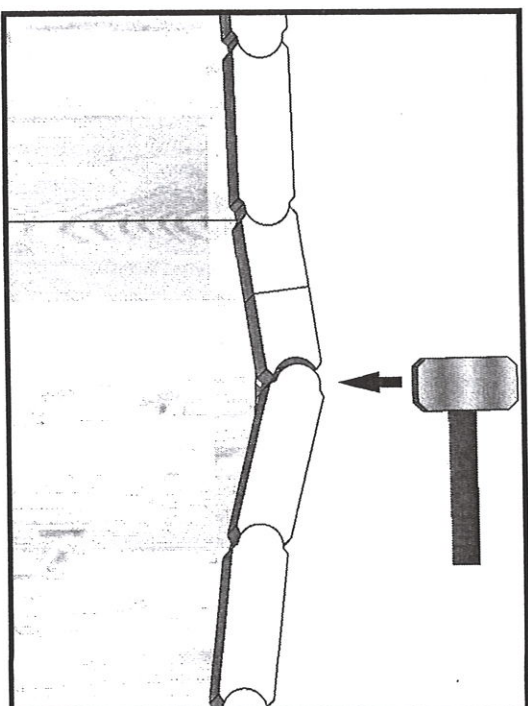
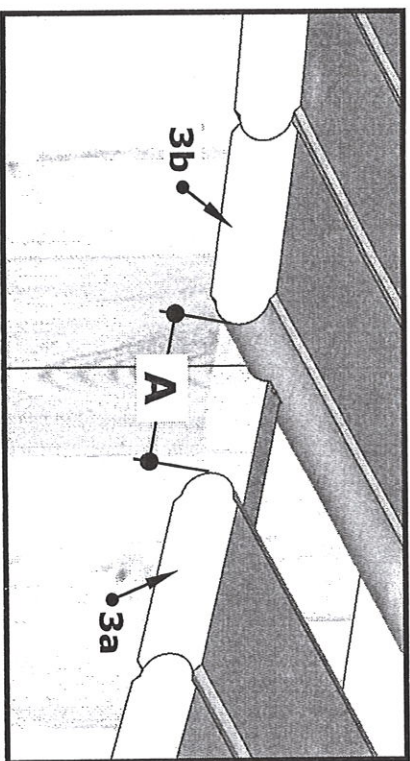
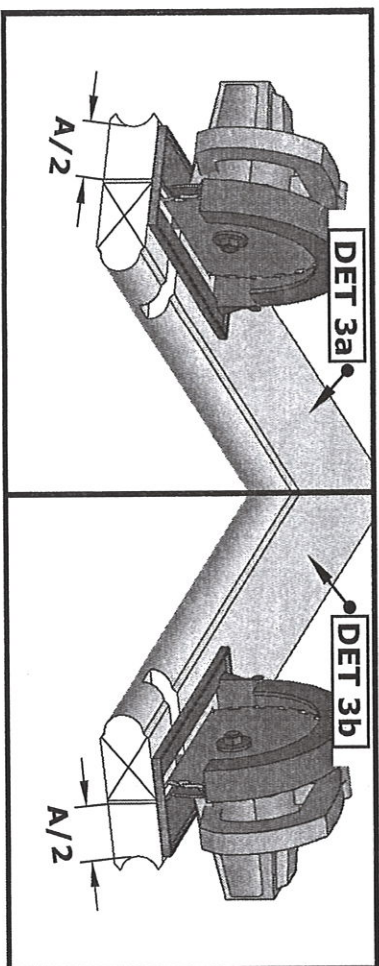
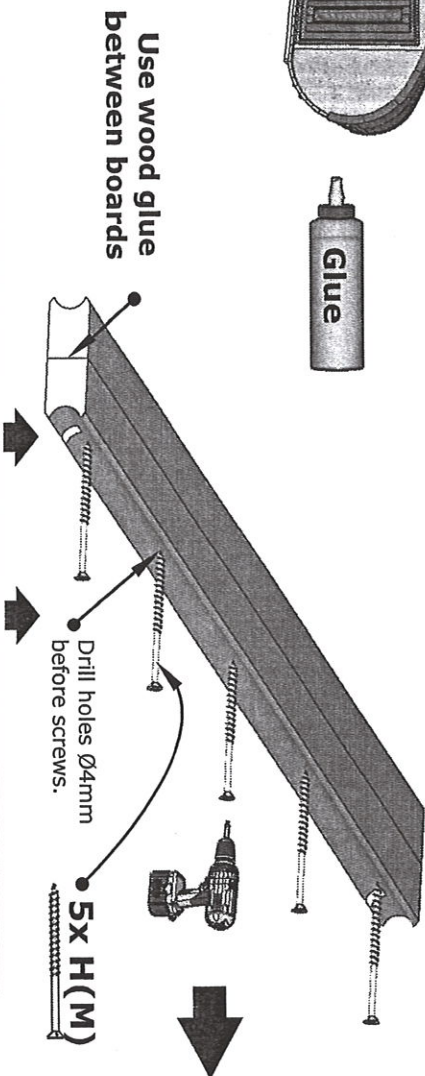
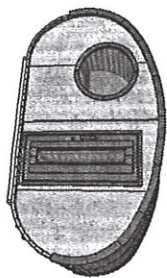

# Sauna "Hobbit" 4 x 1,95

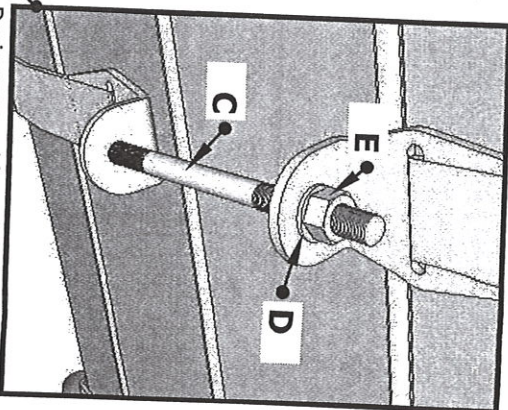
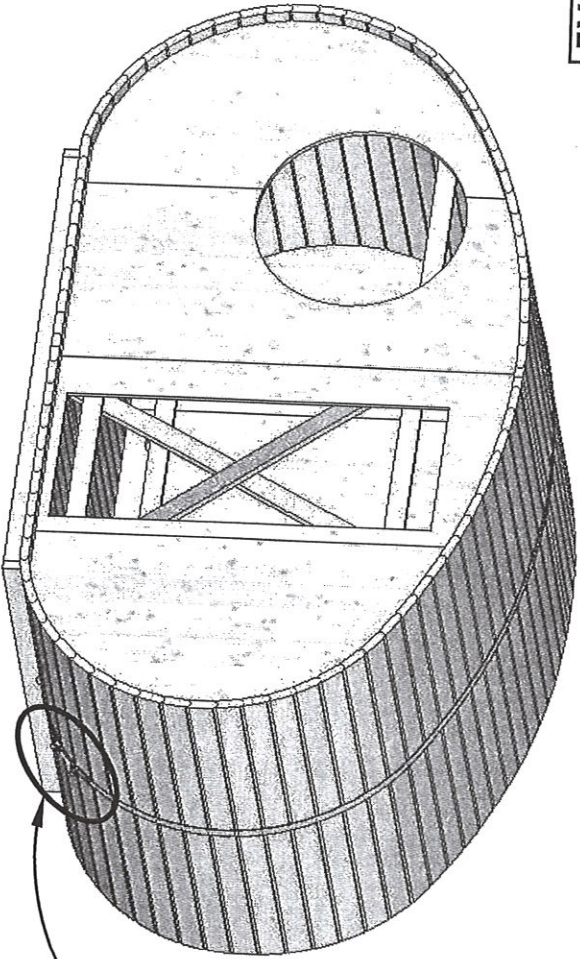
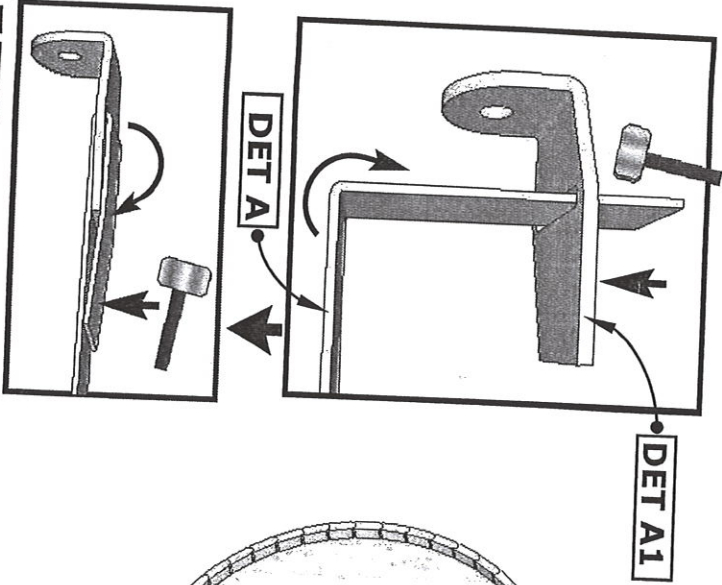
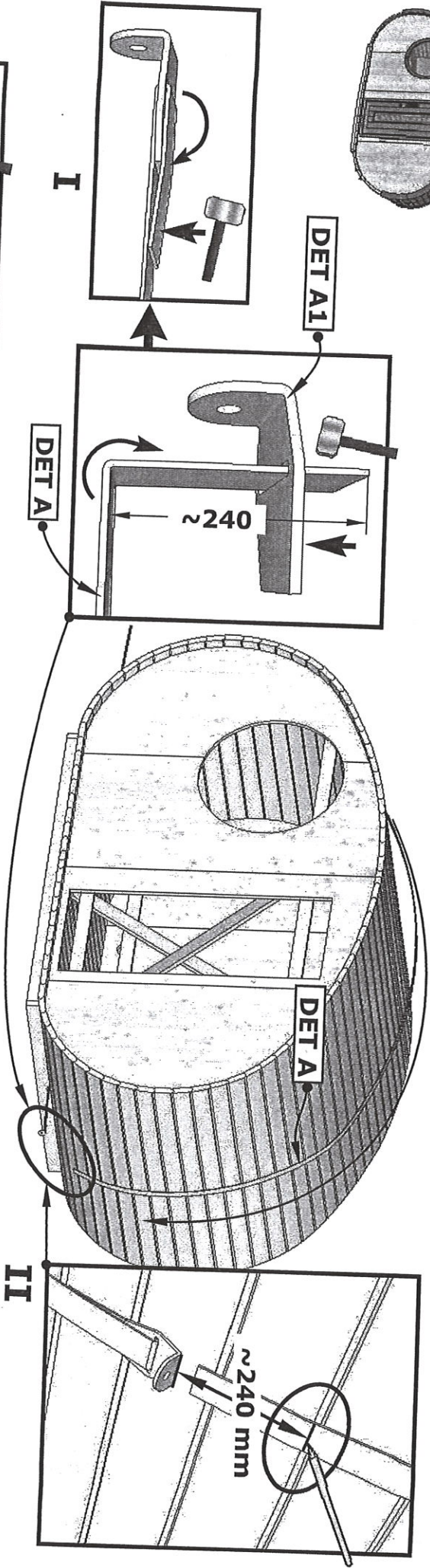

During assembly and retightening the threaded rods, use oil (Würth HPS 1400 or similar) to avoid "cold welding" and it is also easier tightening.



## 8. III

## IV

# Sauna "Hobbit" 4 x 1,95

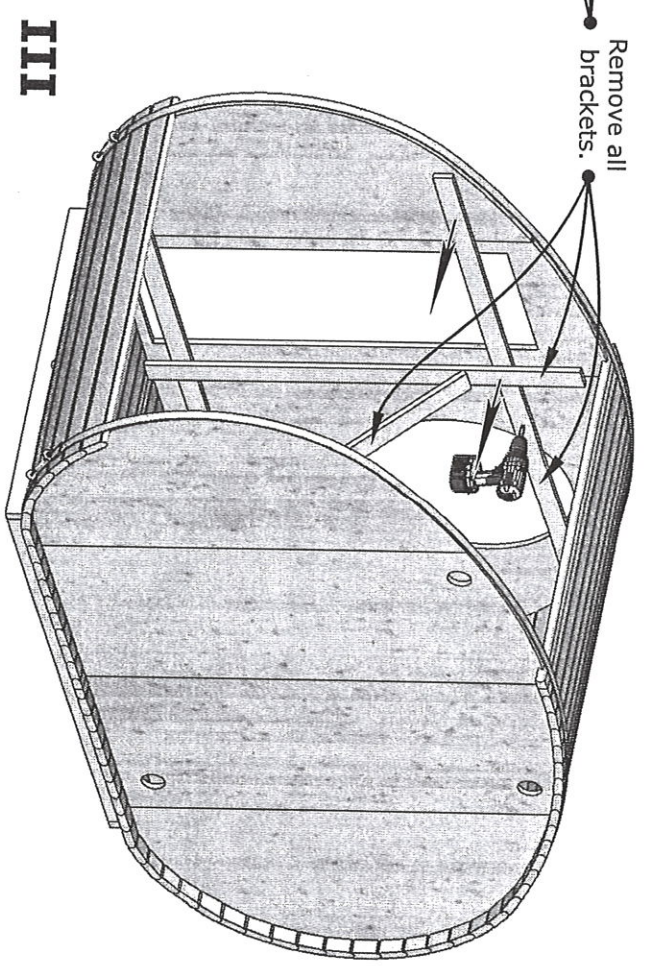
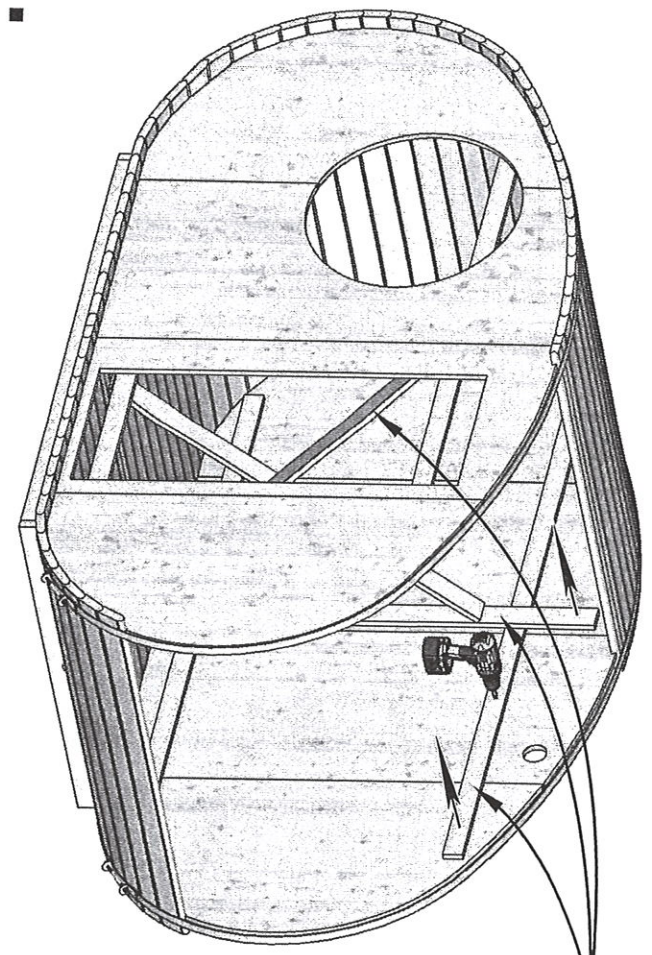
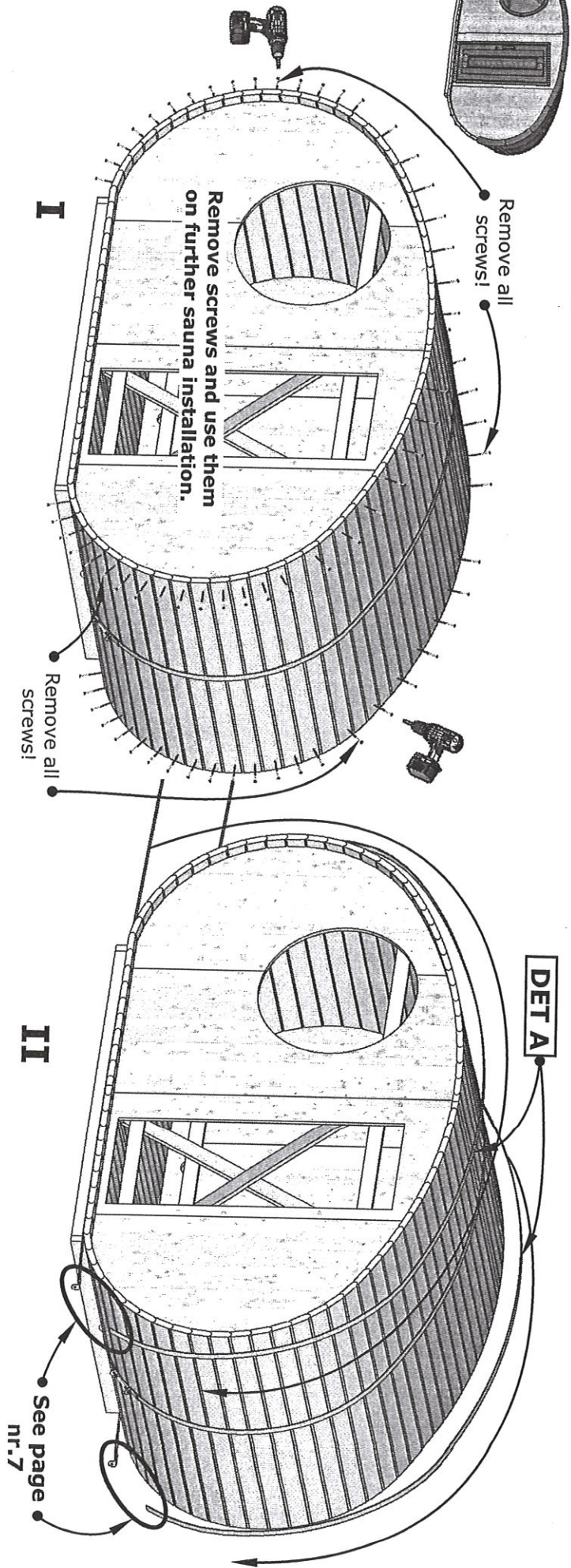
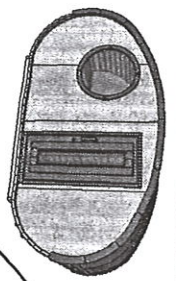

9.

III

Remove all brackets.

# Sauna "Hobbit Tiny" 4 x 1,95

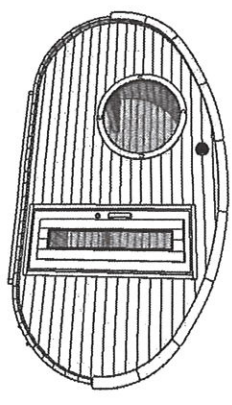

Mark openings and cut out.

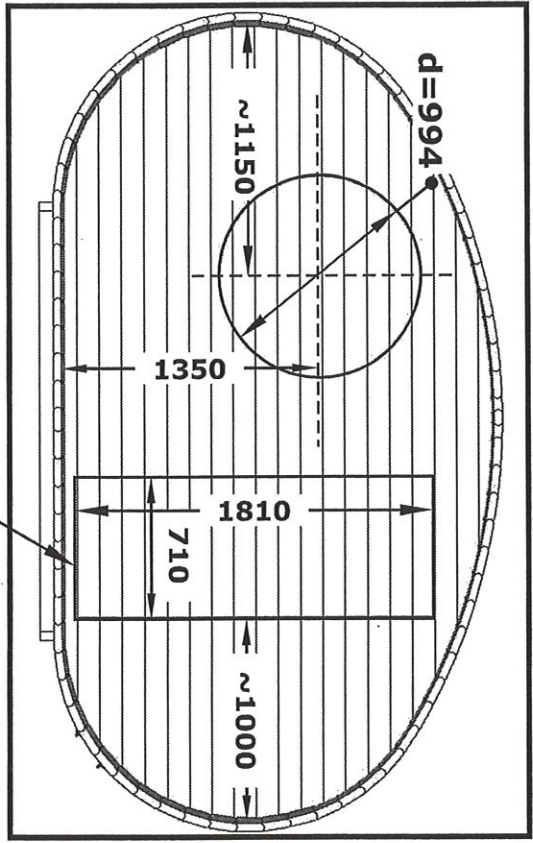

II

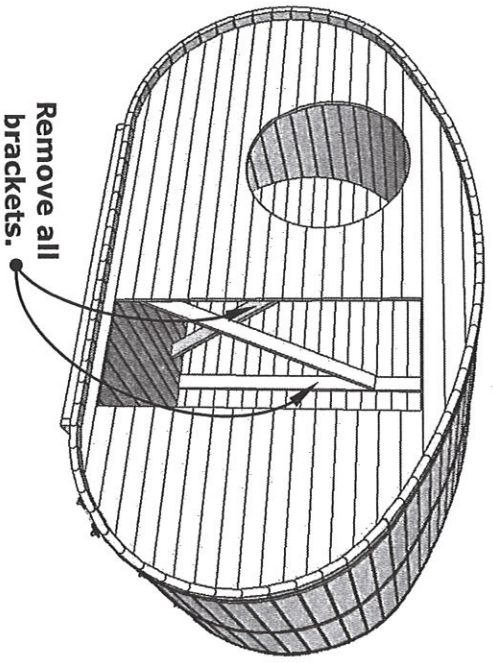
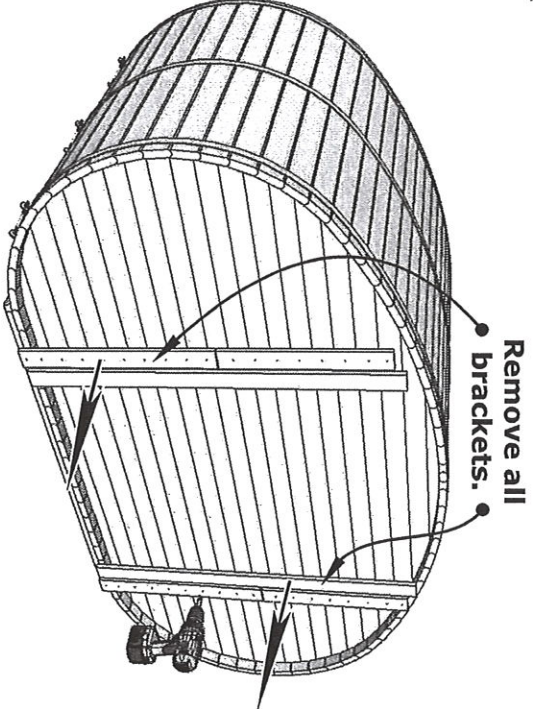
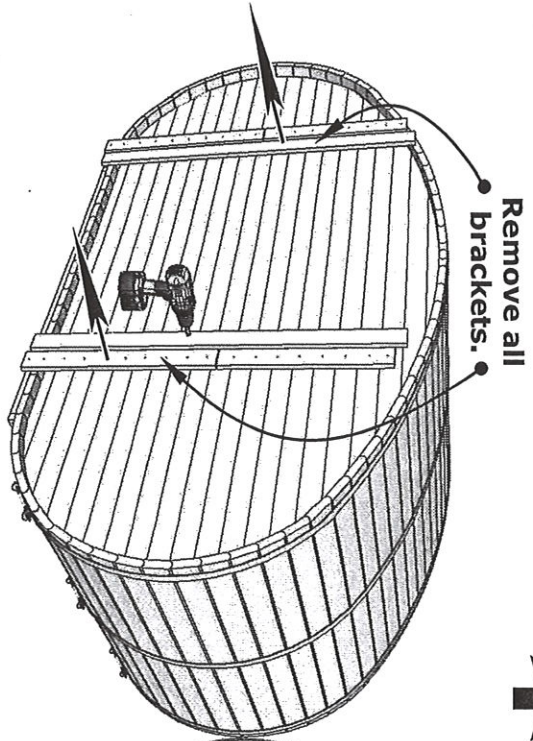
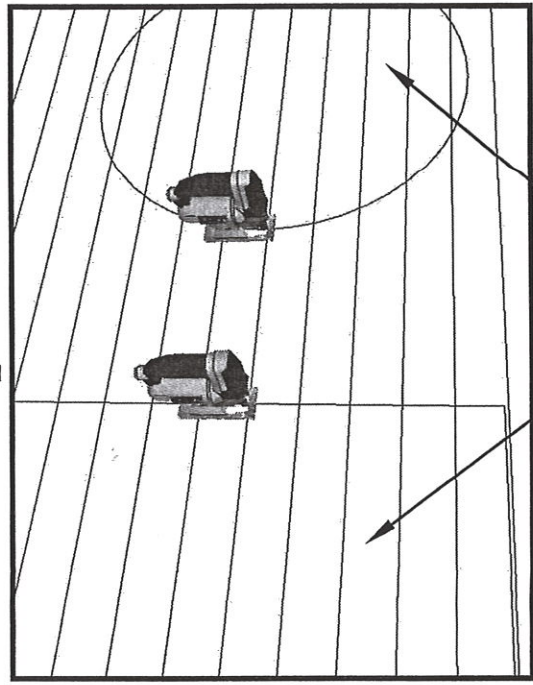

# Sauna "Hobbit Tiny" 4 x 1,95

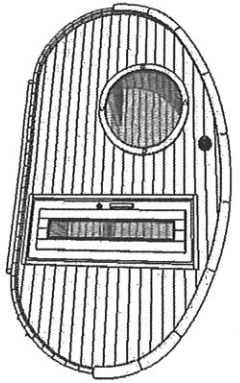

Use waterlevel for installation.  
Place doors and windows from inside.

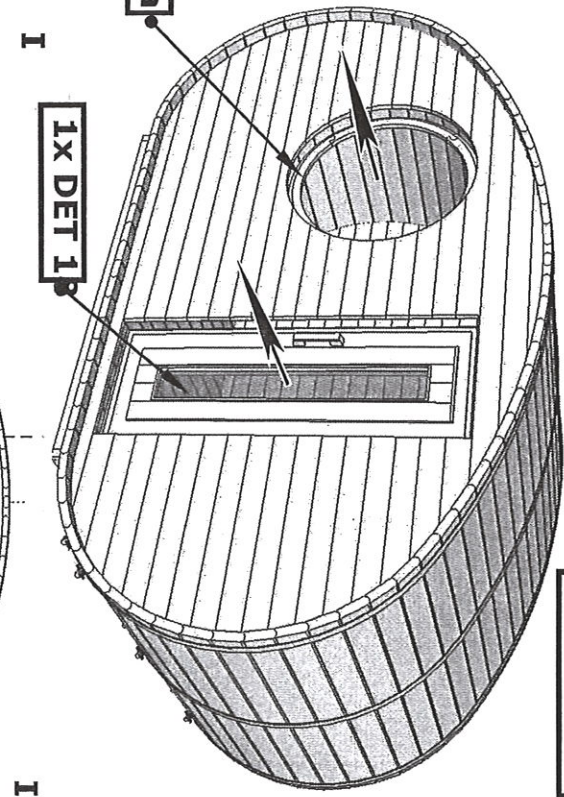

NB! Vertically fix screw in every board.

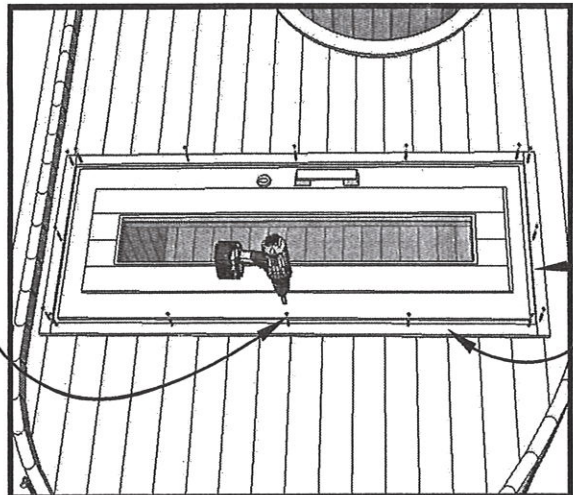
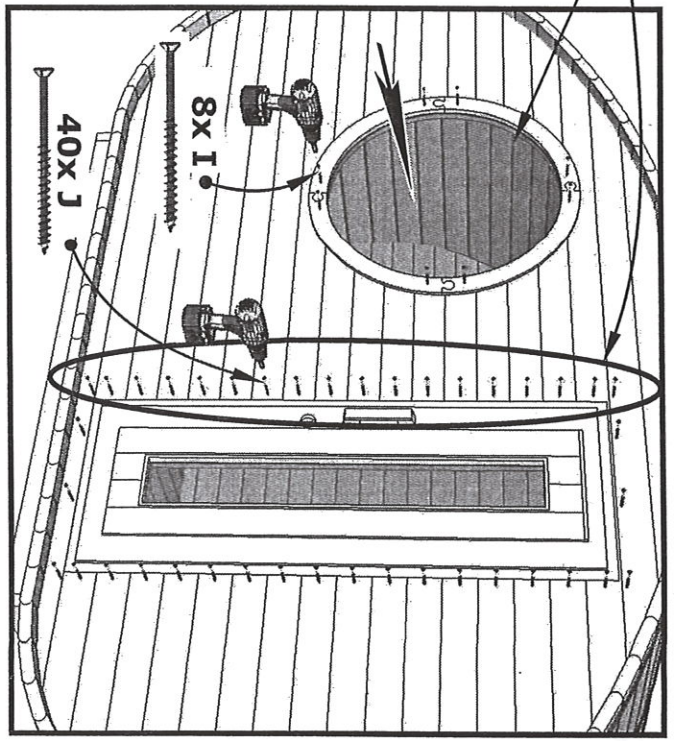

# 11.

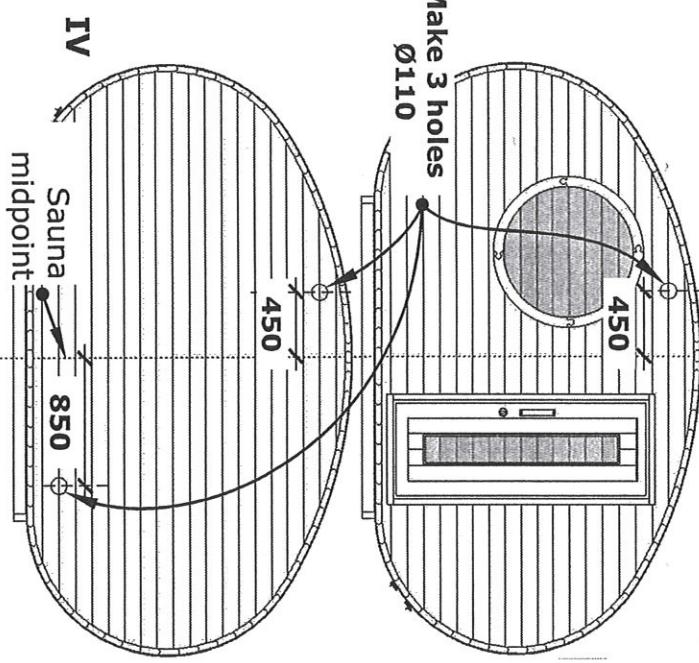

II

IV

III

I

# Sauna "Hobbit" 4 x 1,95

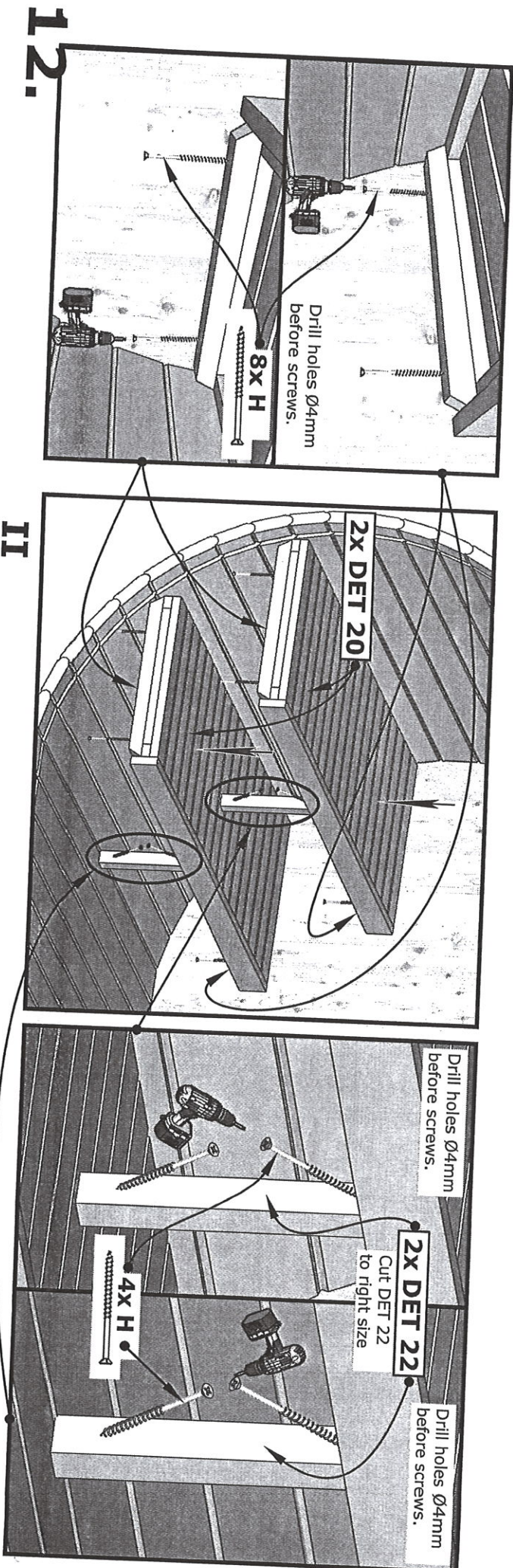
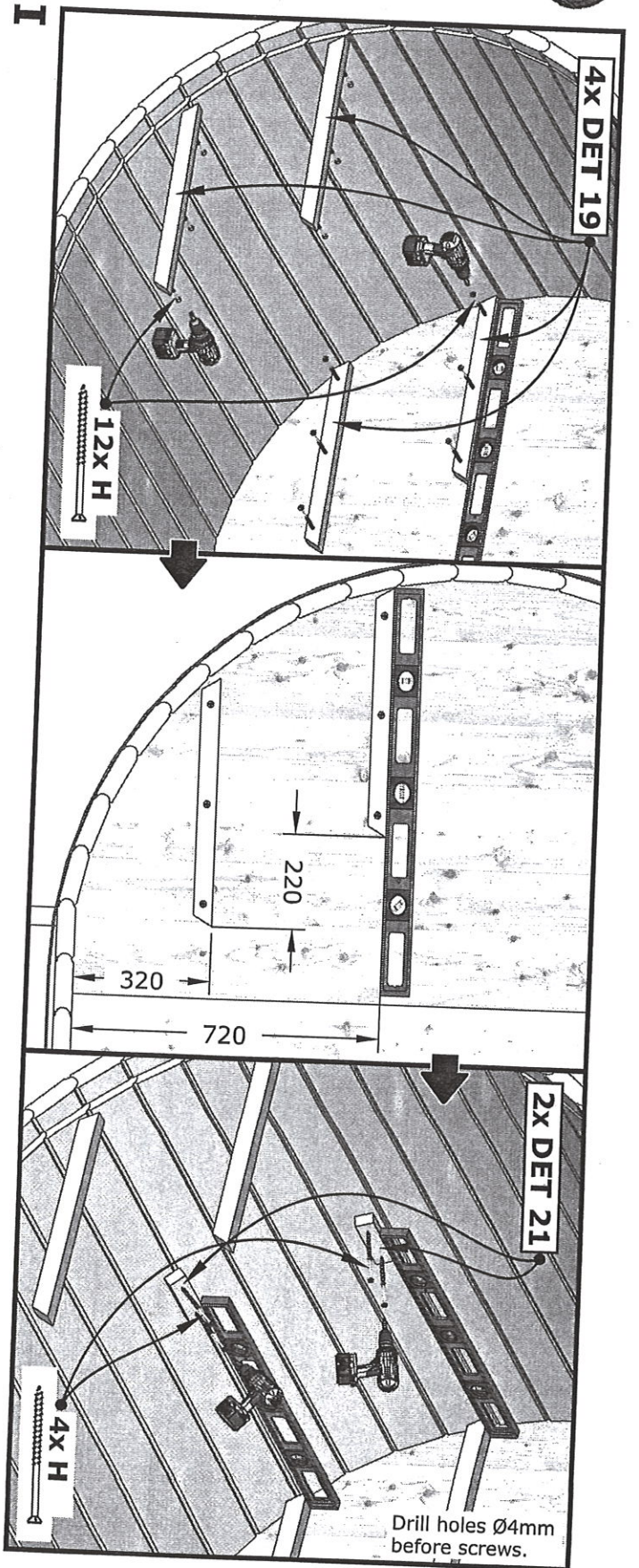
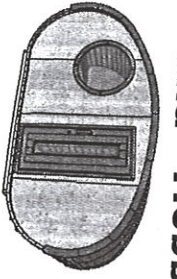

**12.**

**II**



# Sauna "Hobbit" 4 x 1,95

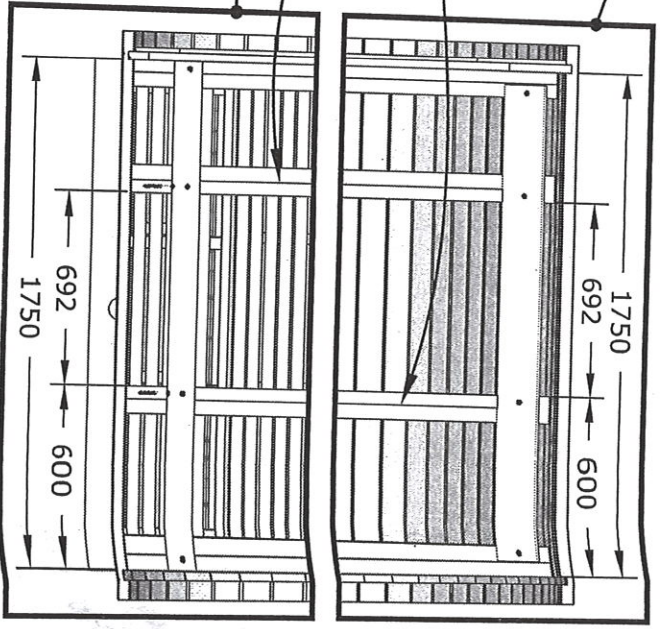
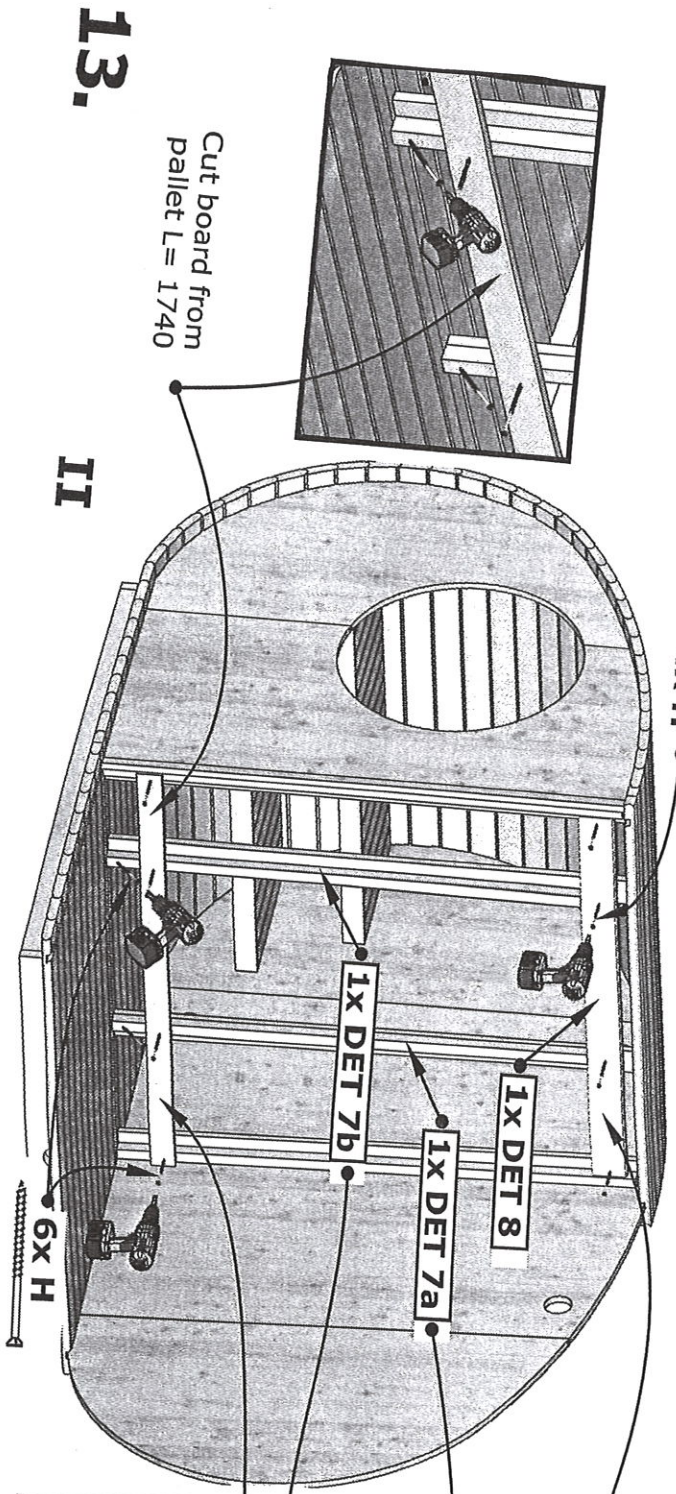
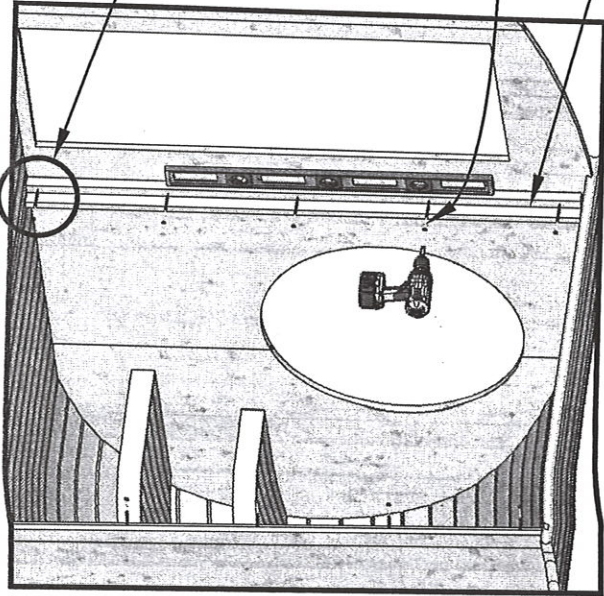
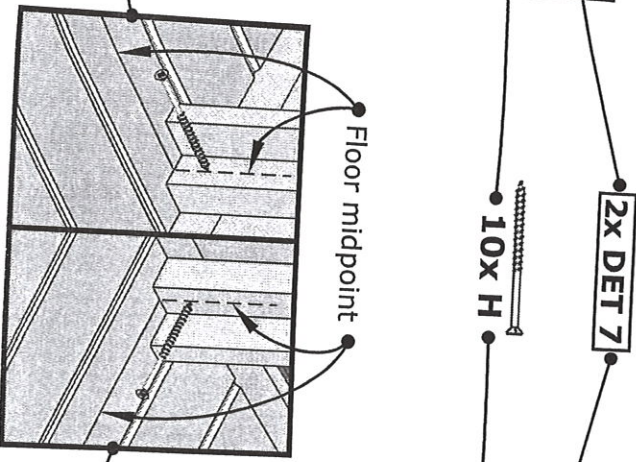
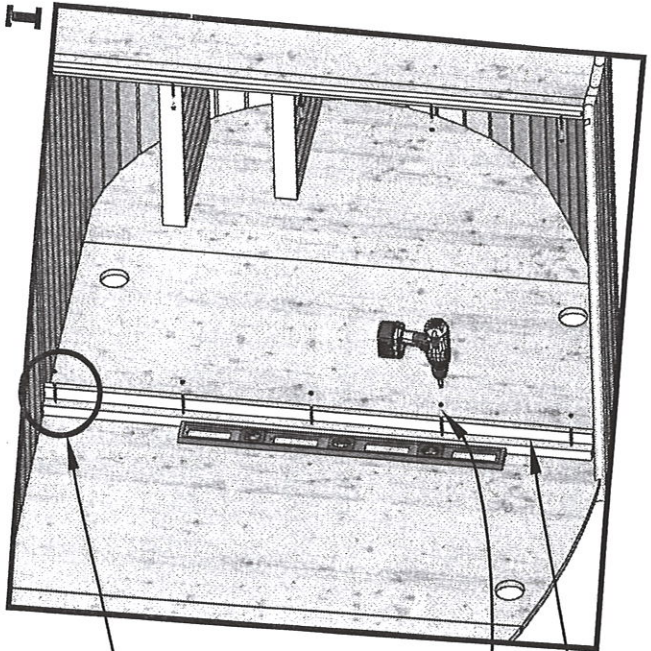

# Sauna "Hobbit" 4 x 1,95

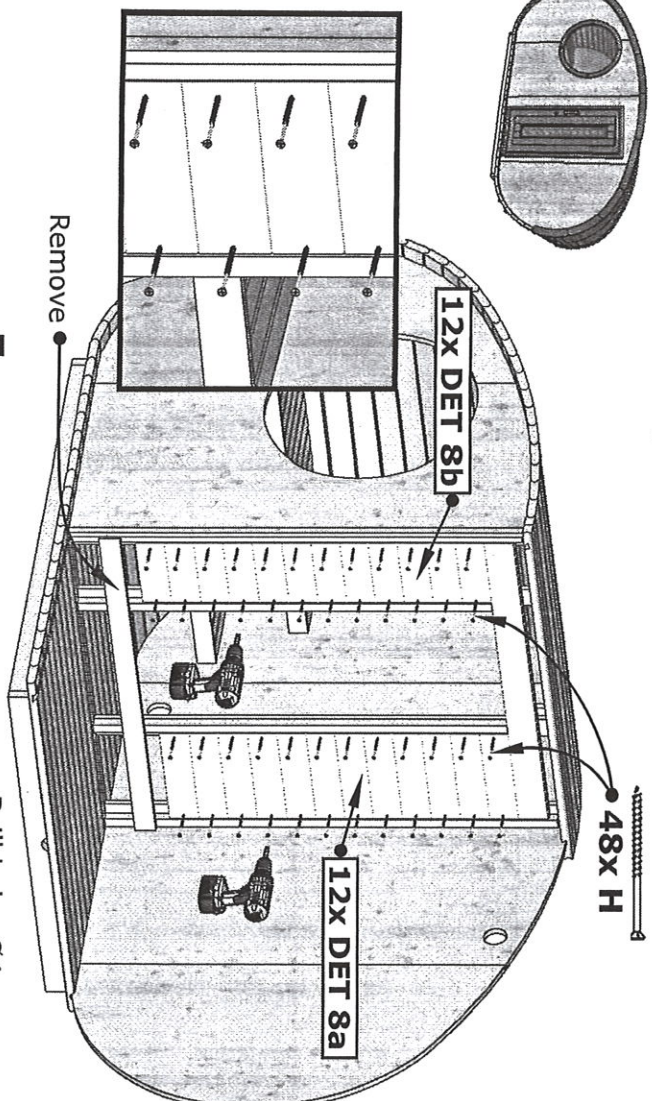

## I

Drill holes  $\varnothing 4\text{mm}$  before screws

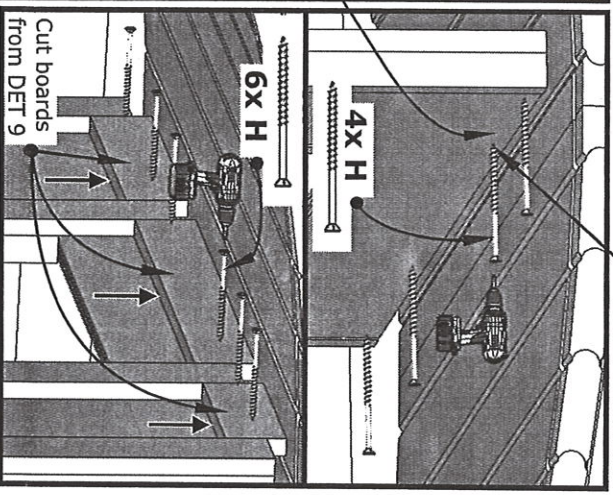
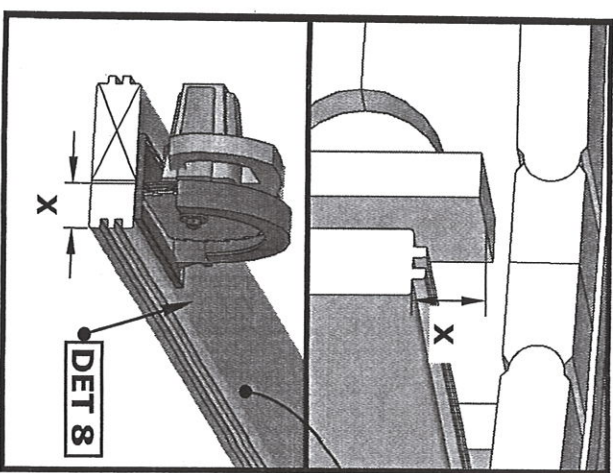

## II

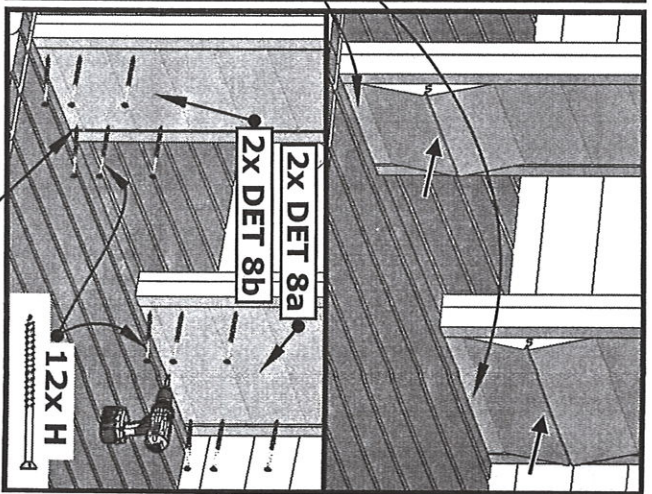
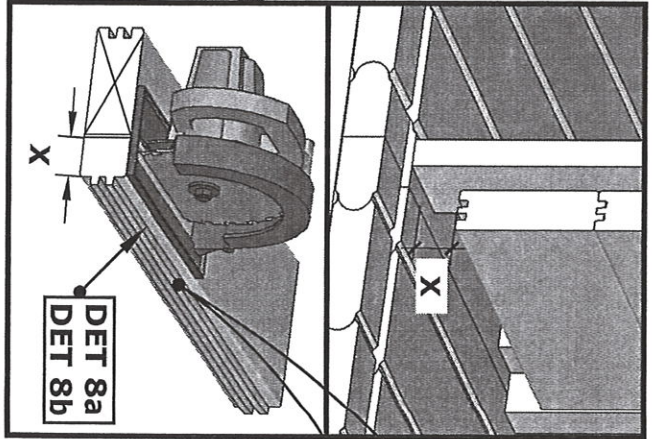

## IV

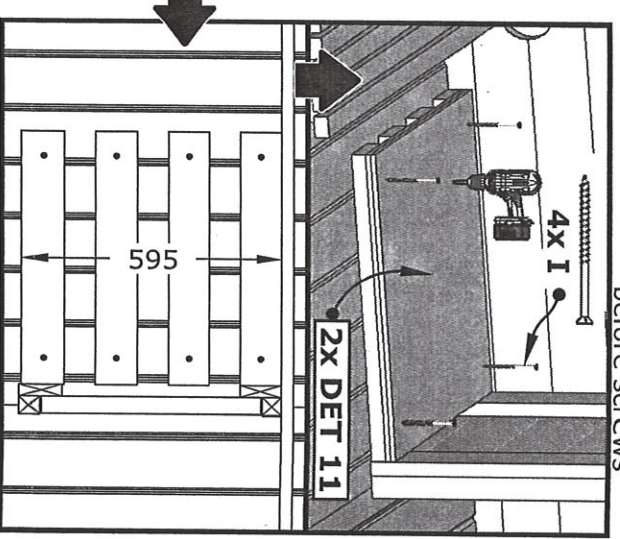
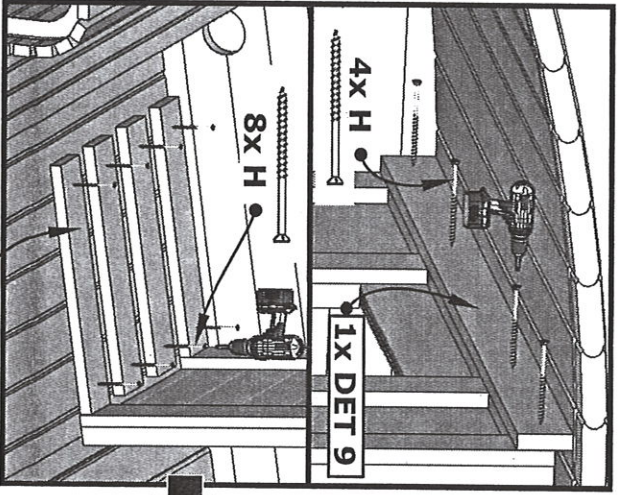

# 14. III

Sauna "Hobbit" 4 x 1,95

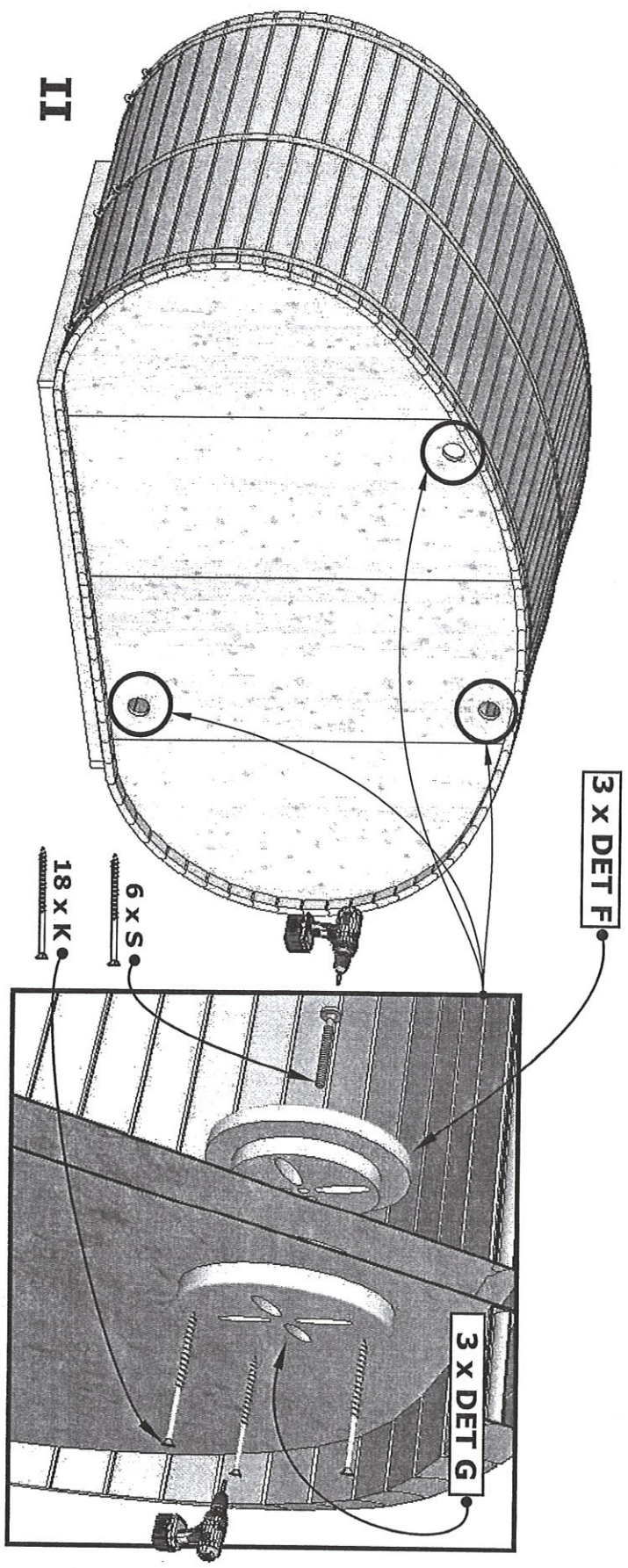
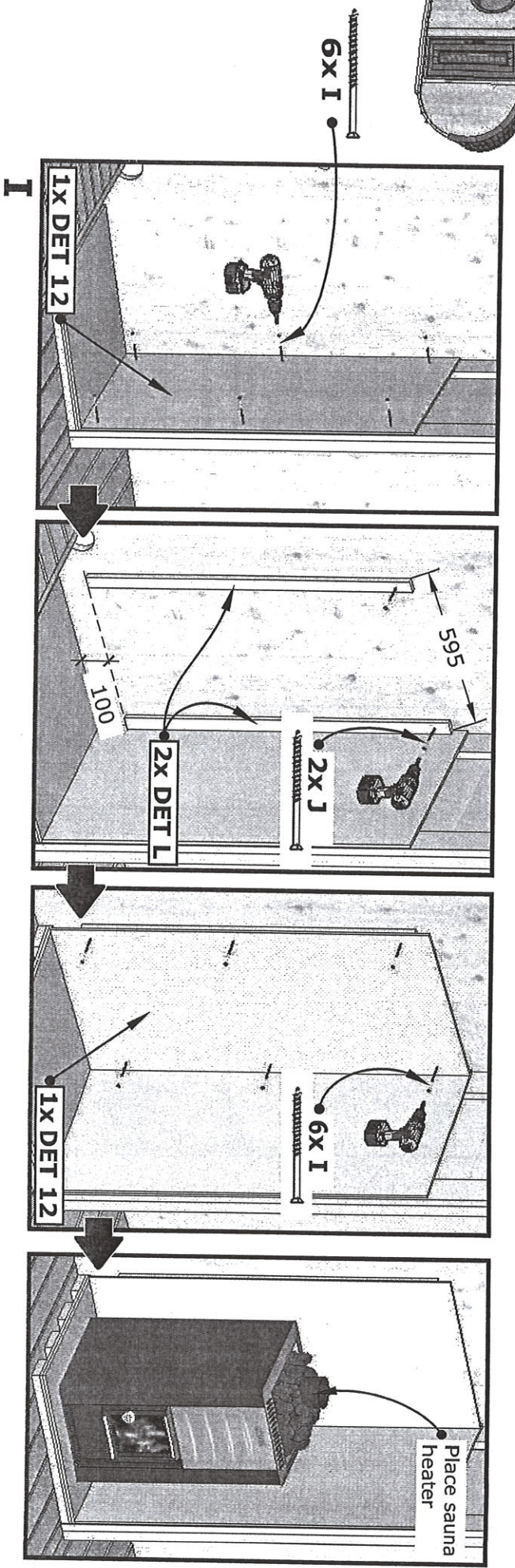
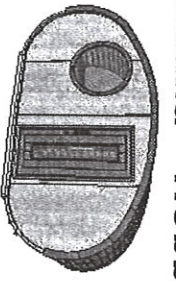

15. II

# Sauna "Hobbit" 4 x 1,95

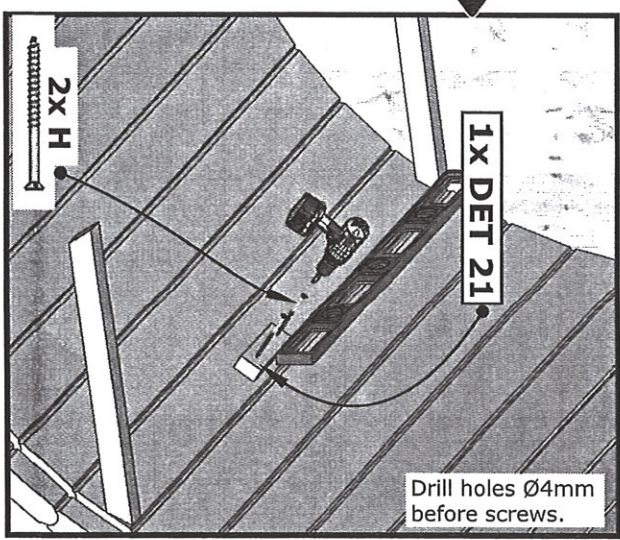
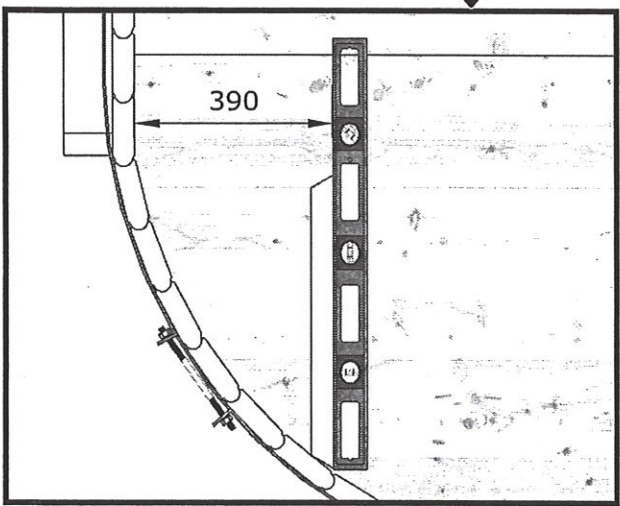
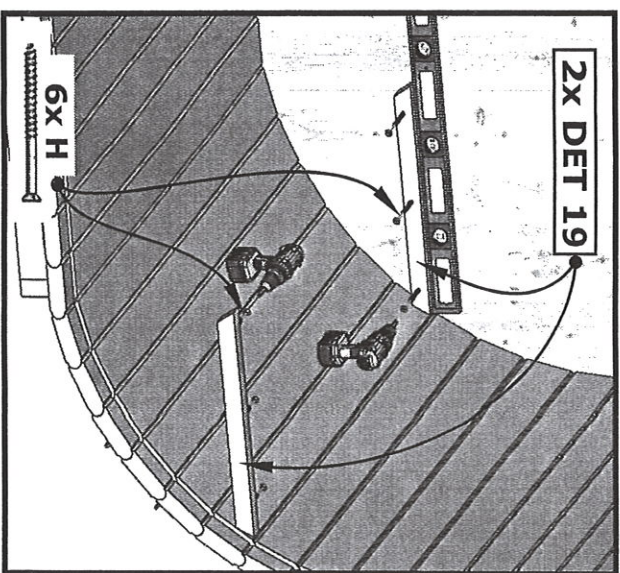
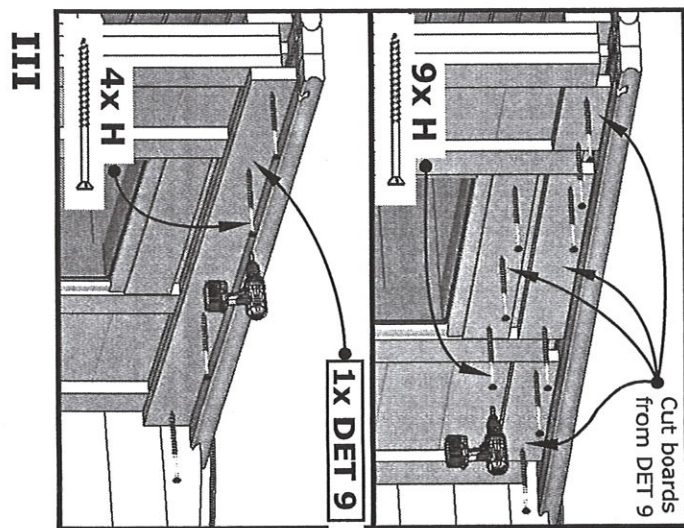
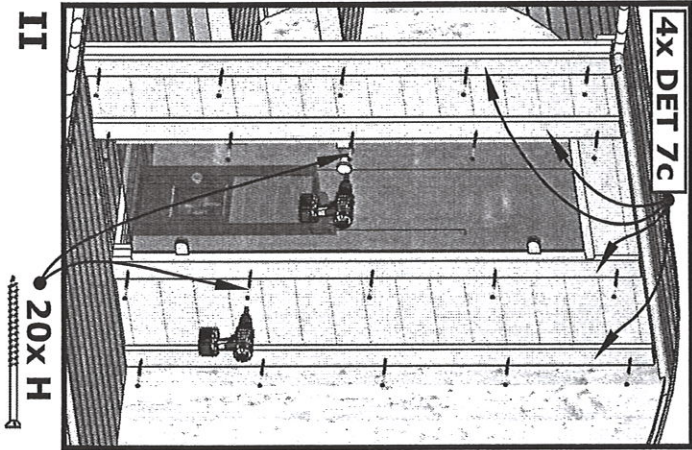
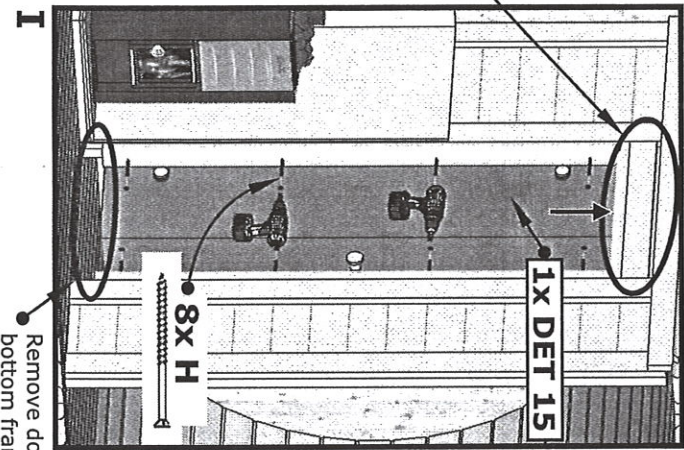
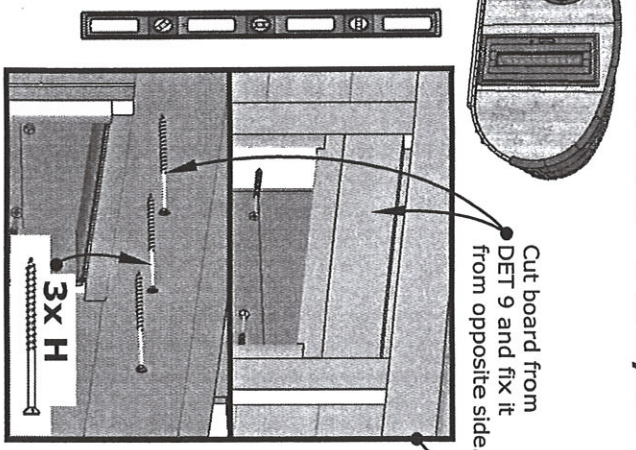
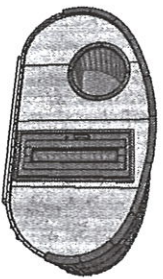

# 16. IV

# Sauna "Hobbit" 4 x 1,95

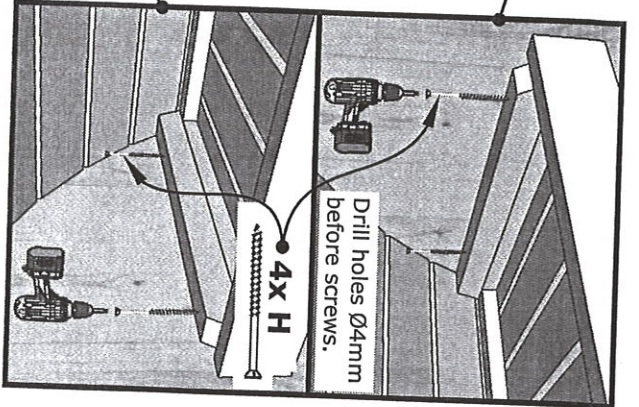
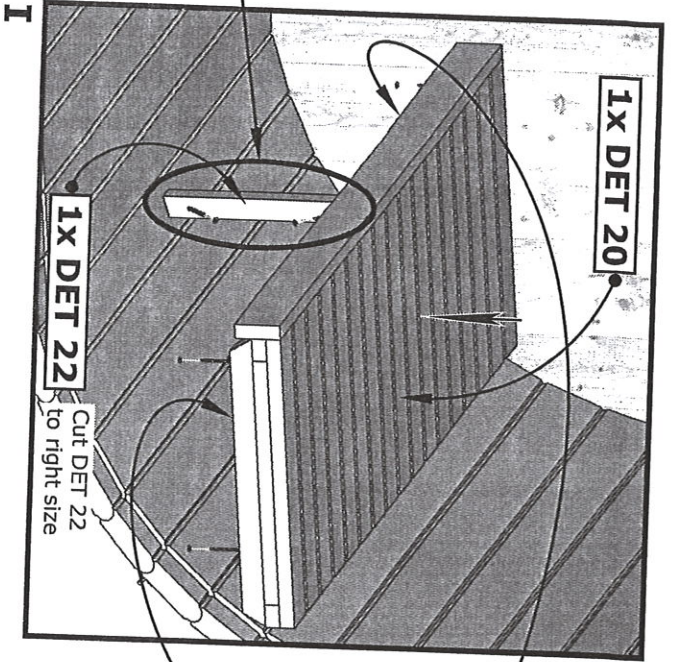
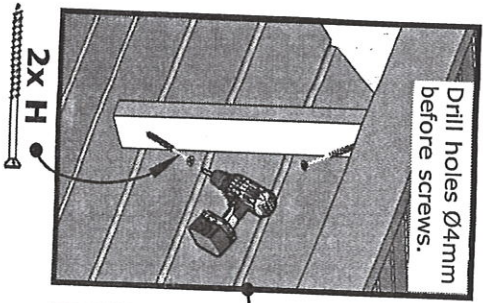
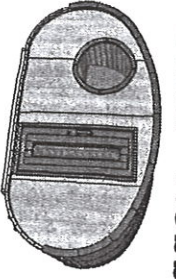

# Sauna "Hobbit" 4 x 1,95

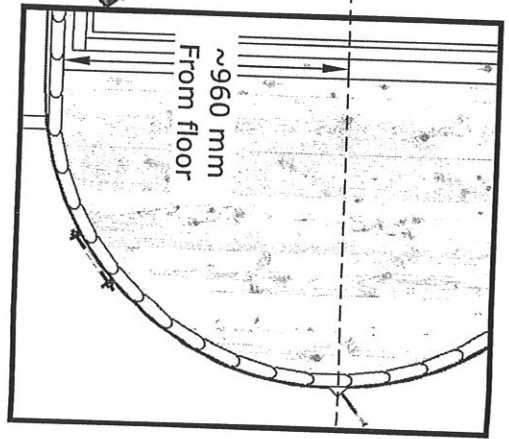
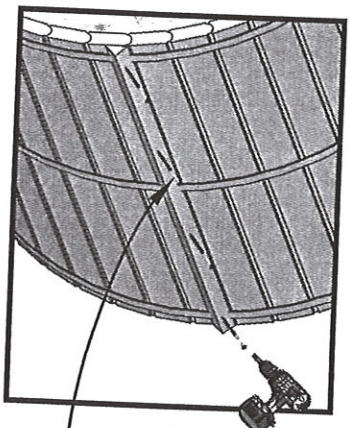
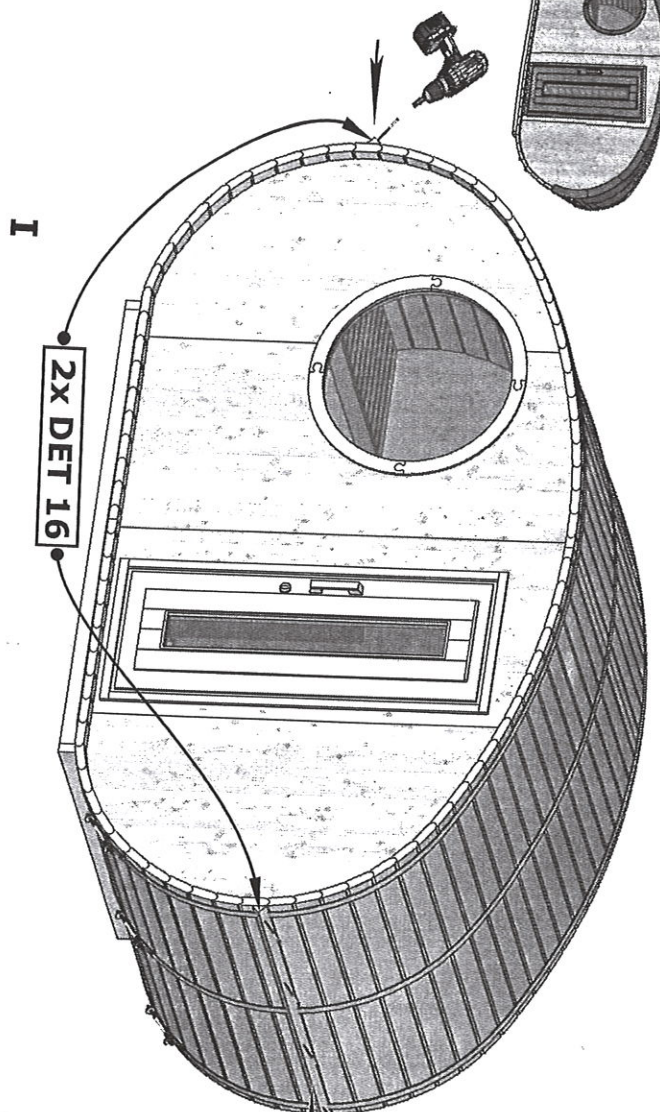
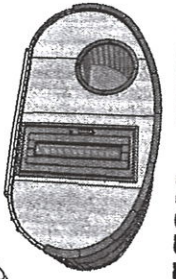

NB! Before roof shingles, install underlay felt.

Check also roof shingles installation manual inside package.

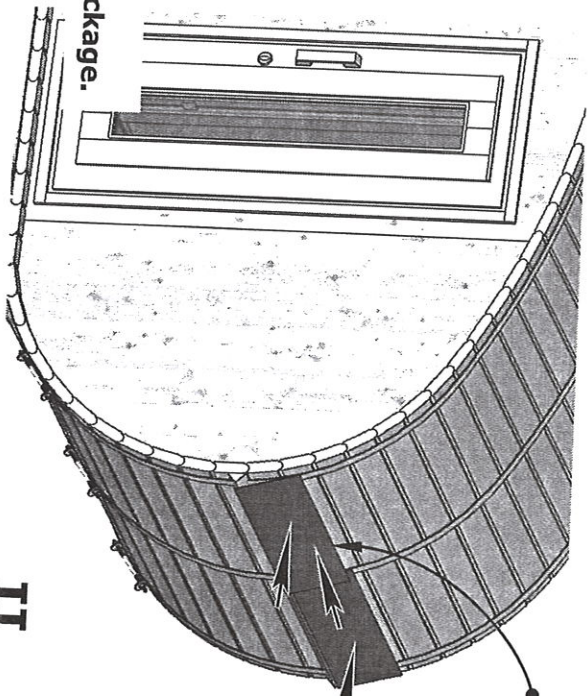

**II**

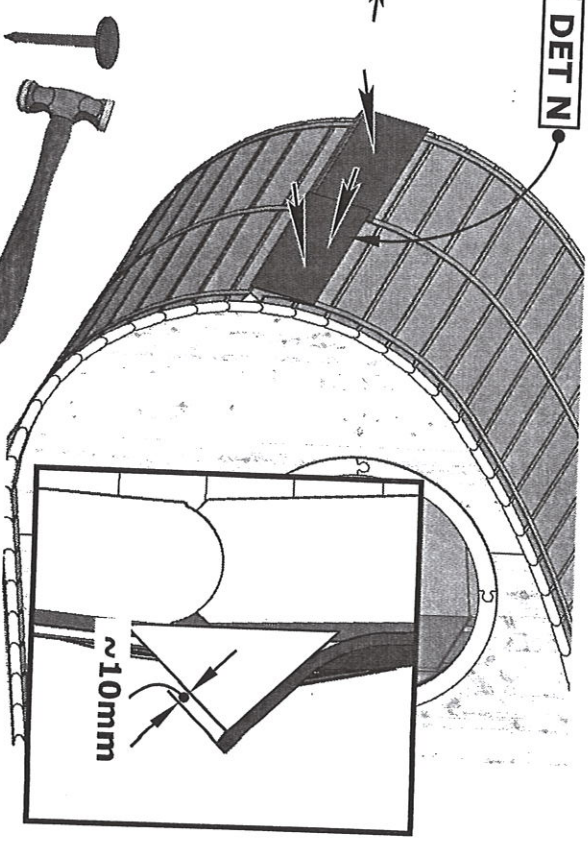

# Sauna "Hobbit" 4 x 1,95

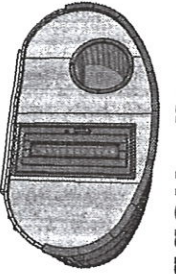

Shingles overlap on top

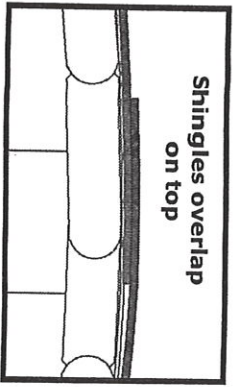

Check also roof shingles installation manual inside package.

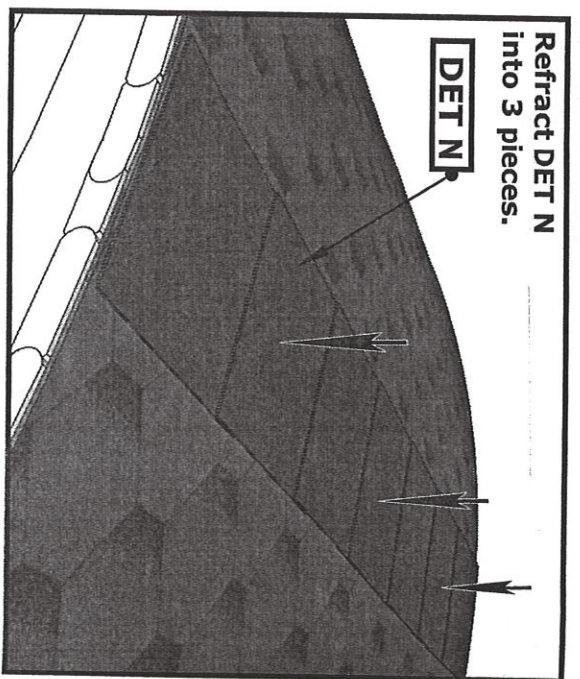
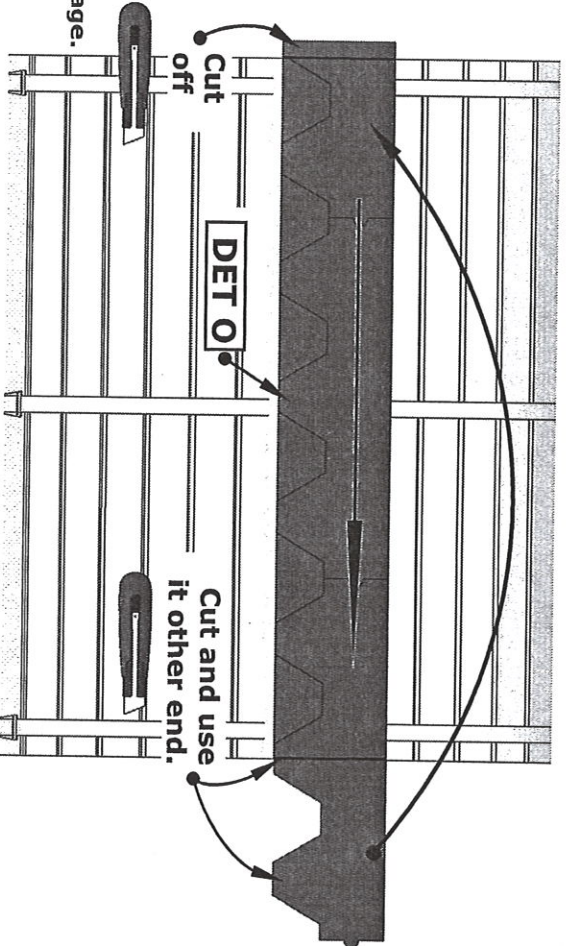

I

19.

III

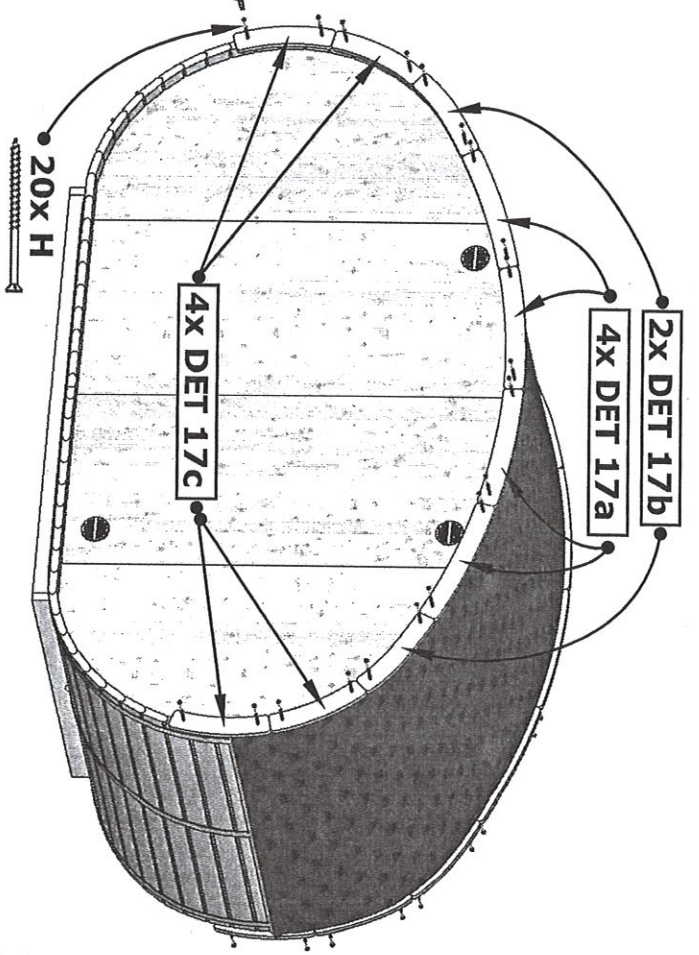
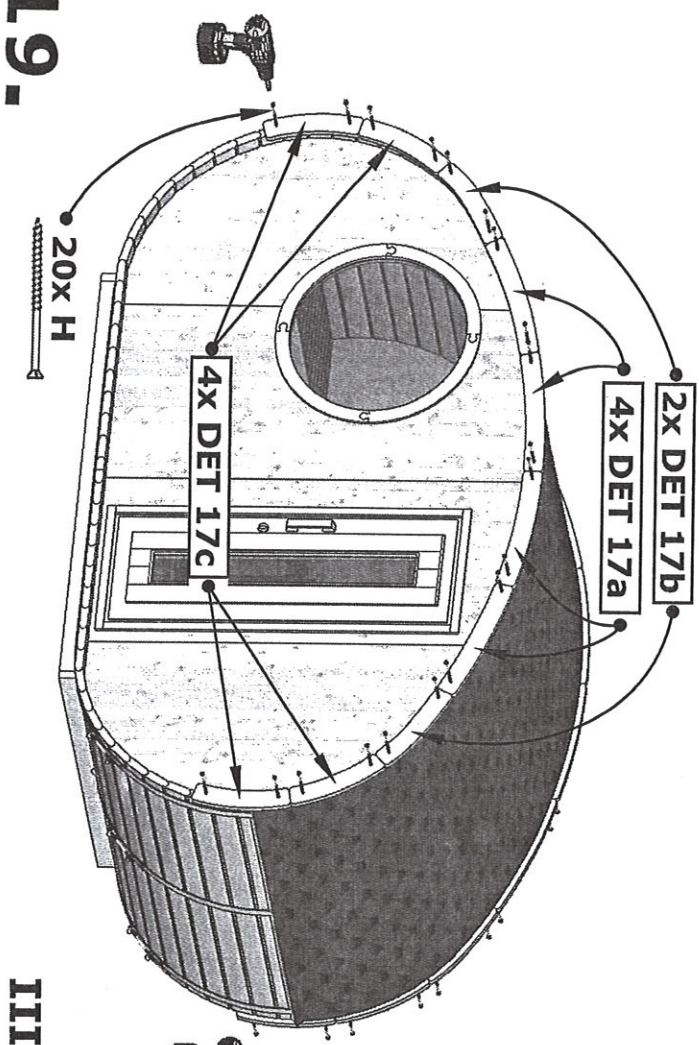

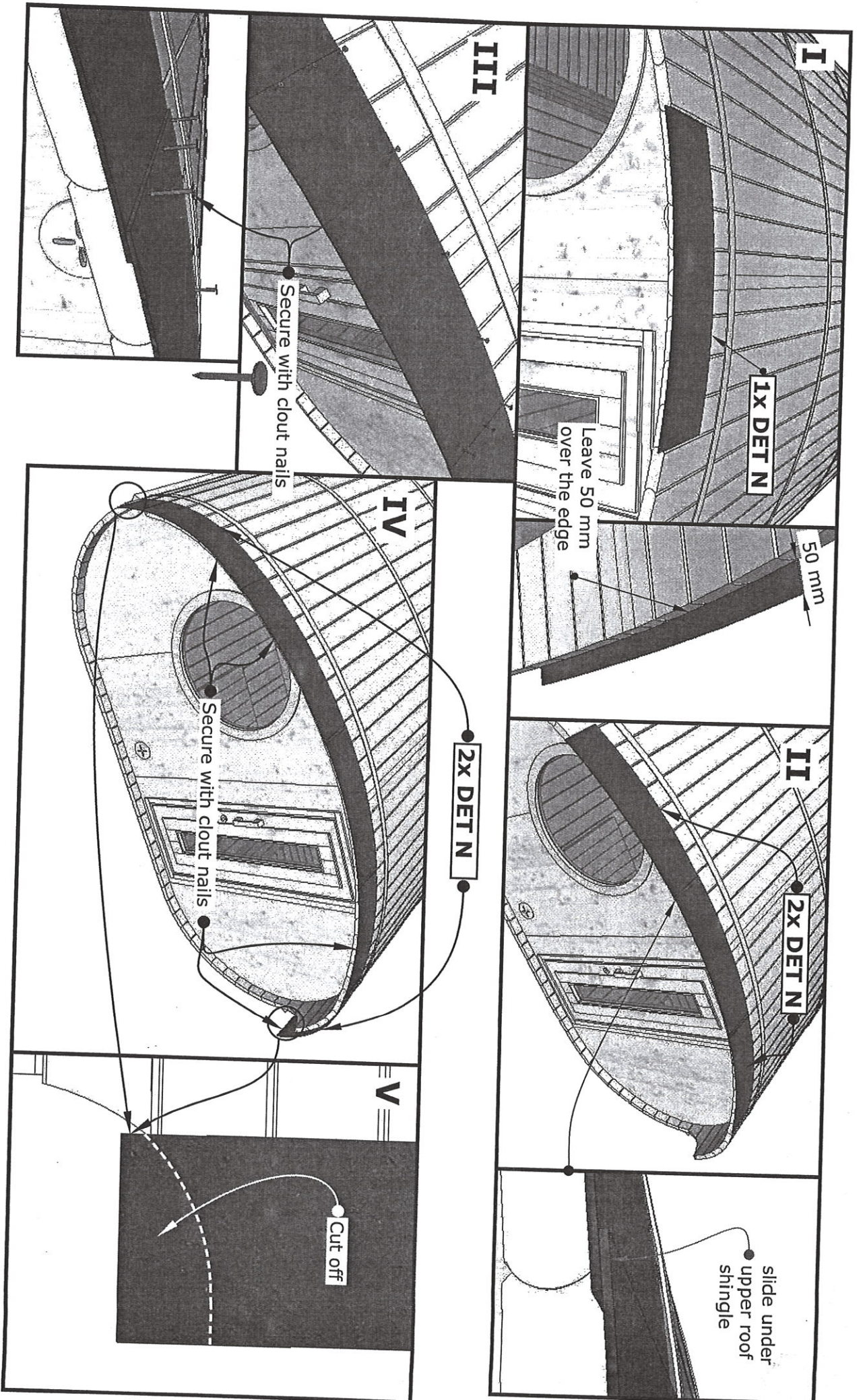

Ka.



I

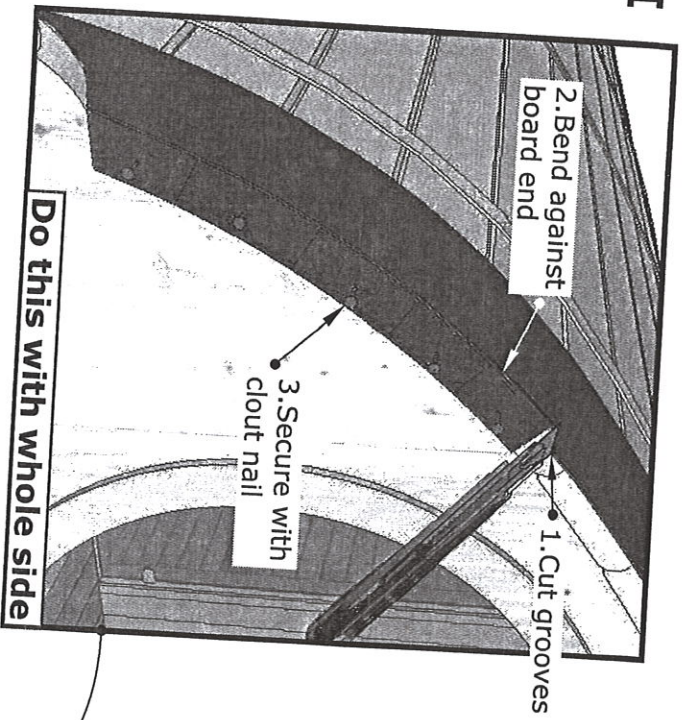

II

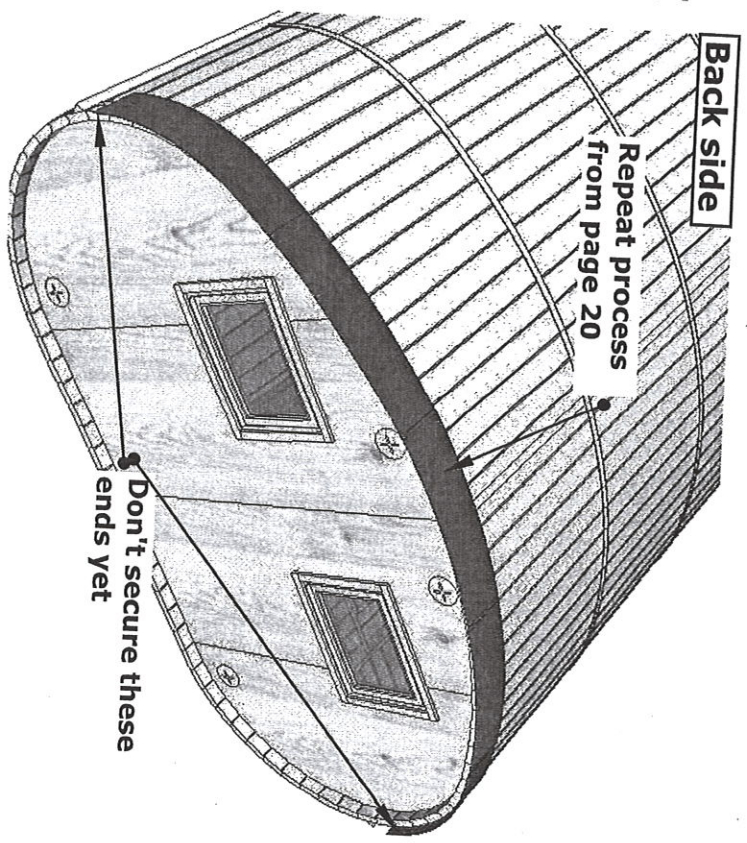

III

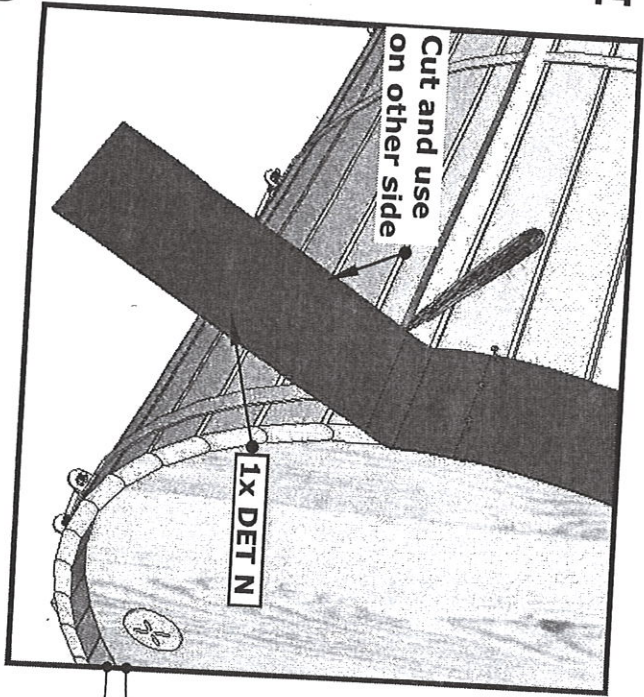

IV

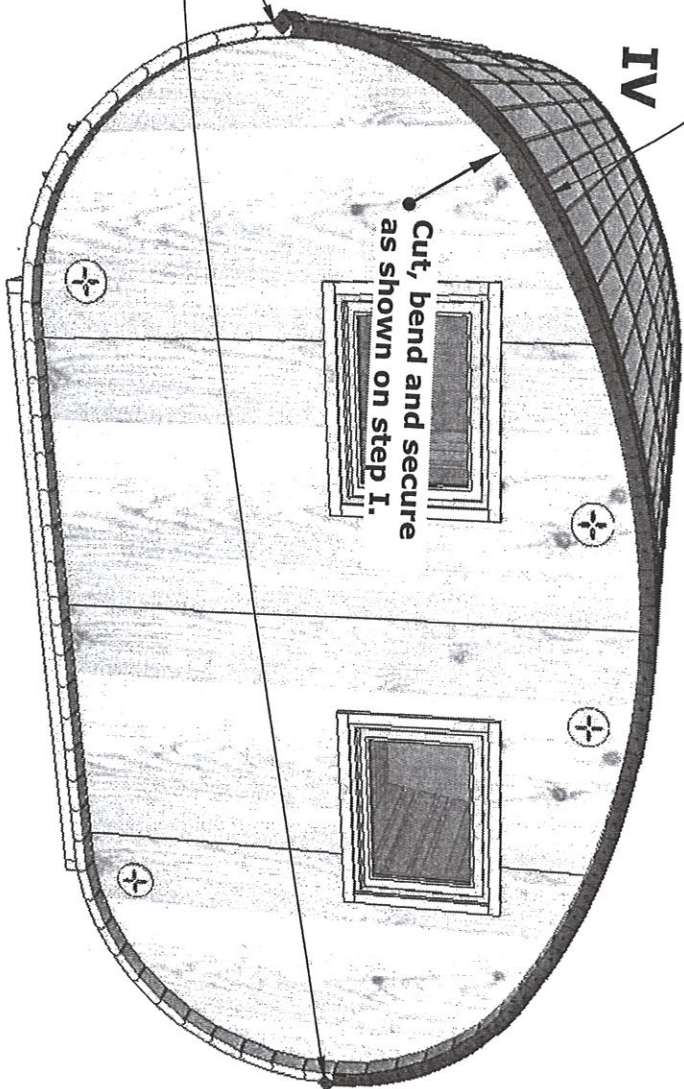

Kb.